

MASERATI GRANTURISMO MC SERVICE MANUAL



Quick Links

[Engine Specifications](#)

[Maintenance Procedures](#)

[Electronic Devices](#)

[Fuse and Relay Boxes](#)

[Electric and Electronic Systems](#)

Table of Contents

[Index](#)

[Contacts](#)

[Maintenance Check List](#)

[Periodic Checks and Life Limits](#)

[Dimensions and Weight](#)

[Ballast](#)

[Engine specifications](#)

[Maintenance procedures](#)

[Electronic devices](#)

[First engine start up procedure](#)

[Oil level check procedure](#)

[Engine auxiliary belt and water pump belt \(check and replacement\)](#)

[Water pump belt \(only replacement\)](#)

[Transmission](#)

[Gearbox](#)

[Transmission Ratios](#)

[Oil level check procedure \(gearbox\)](#)

[Clutch Replacement Procedure](#)

[Gearbox Procedures](#)

[First gearbox start up procedure](#)

[Air bleed procedure on the clutch actuator system](#)

[Self setting gearbox procedure](#)

[Brakes](#)

[Front/Rear Caliper](#)

[Calipers: Tightening torques](#)

[Brake Disks](#)

[Brake Pads](#)

[Pedal box with balance bar](#)

[Master cylinders](#)

[Brake Fluid Tanks](#)

[Balance Bar](#)

Balance knob

Standard Setup (Ref. Trofeo car 2015 spec)

Setup Adjustment

Ride Height Adjustment

Ride Height Important Note

Caster Check/Camber Adjustment

Toe Adjustment/Restoration after camber adjustment

Kinematics

Toe vs Wheel Travel (Positive = Toe In)

Camber vs Wheel Travel (Positive = Toe Out)

Caster vs Wheel Travel

King Pin vs Wheel Travel

Half-Track vs Wheel Travel

Wheel/Sprig Ratio vs Wheel Travel

Wheel/ARB Ratio vs Wheel Travel

Roll Centre Height vs Wheel Travel

Antidive vs Wheel Travel

Antisquat vs Wheel Travel

Springs

Front/Rear Suspension Springs

Spring Ring Adjustment

Dampers

Maserati Gran Turismo MC Trofeo - Rear - MAS3

Bump Stop

Packers

Front/Rear Anti Roll Bar

Steering system

Steering rack

Suspensions - Tightening torques

Front Suspension Assembly

Rear Suspension Assembly

Suspension movement check

Front Hub Carrier Assembly

Rear Hub Carrier

Wheel spacers

Lower front subframe engine support plate

Wheels

Wheel Rims

Tyres

Tyre Pressure

Cockpit

Steering wheel commands

Central console commands

Dashboard

Alarm screen and warning lights

Rolling rest procedure

Fuel system

Fuel tank

Fuel Pumps

Fuel level

Refuelling

Emptying

Quick Refuelling optional system

Electric and Electronic systems

Fuse and Relay boxes

Main Breaker Relay

Sensors kit installation and configuration

CAN connector

Vehicle connector

Download/Configuration cable

Maserati Ethernet Data Cable (w/o CAN connection) p/n: 232816

GT4 upgrade kit 2016

Specific maintenance tools

Other ManualsLib Projects



MASERATI

Corse GT



MASERATI GRANTURISMO MC

SERVICE MANUAL



Index

1. Contacts	p3
2. Introduction	p4
3. Maintenance Check List	p4
4. Fluids and Lubricants	p7
5. Dimensions and Weight	p8
6. Engine	p9
6.2 Maintenance Procedures (engine)	p10
7. Transmission	p15
7.2 Clutch	p18
7.3 Maintenance Procedures (gearbox)	p19
8. Brakes	p33
9. Setup	p38
11. Suspensions	p61
12. Wheels	p73
13. Cockpit	p74
14. Fuel System	p82
15. Electric System	p87
16. GT4 Upgrade kit 2016	p97
17. Specific Maintenance Tools	p97

1. Contacts**1.1. Manufacturer**

Company name:	Maserati S.p.A.
Address:	Viale Ciro Menotti, 322 41121 Modena (MO) ITALY

1.2. Sales / Marketing

Name:	Roberto Bozzi
Address:	Viale Ciro Menotti, 322 41121 Modena (MO) ITALY
Telephone:	+39 059 866 3488
Mobile:	+39 348 573 2880
E-mail:	roberto.bozzi@maserati.com

1.3. Spare parts

Name:	Alberto Ballarini
Address:	Viale Ciro Menotti, 322 41121 Modena (MO) ITALY
Telephone:	+39 059 866 3170
Mobile:	+39 366 904 3688
E-mail:	alberto.ballarini@maserati.com

1.4. Electronic / Diagnosis support

Company name:	Waycon S.r.l.
Name:	Stefano Moroni
Address:	Via Martinella, 25 41053 Maranello (MO) ITALY
Telephone:	+39 0536 073 277
E-mail:	smoroni@waycon.it

1.5. PR & WEB

Name:	Filippo Ghialamberti
Address:	Viale Ciro Menotti, 322 41121 Modena (MO) ITALY
E-mail:	filippo@oecom.it

2. Introduction

This manual is intended as a general introduction to some specific maintenance procedure of the Maserati GranTurismo MC Trofeo race car.

The destination use is for experienced technicians, familiar with the mechanical checks required by a race car.

3. Maintenance Check List

3.1. Periodic Checks and Life limits

The following components shall be checked and/or replaced within the specified service interval.

If the replacement frequency is not specified, the part need to be replaced in case of defective/abnormal wear found at the scheduled check.

Description	Check Interval	Notes	Recommended replacement frequency	Notes
Engine				
Engine complete rebuild			15000 km	
Oil	500 km	Level Check	5000 km	One time per season
Oil filter			5000 km	One time per season
Auxiliary belt + pulleys	3000 km		10000 km	
Air filter	1000 km		5000 km	
Coolant	3000 km	Level Check	2 years	
Spark plugs			5000 km	One time per season
Coils			10000 km	
Transmission				
Clutch			10000 km	
Gearbox	2000 km	Only Oil Level Check	10000 km	
Transaxle			10000 km	
Drive Shafts		CV joints inspection	1000 km	

Description	Check Interval	Notes	Recommended replacement frequency	Notes
<i>Suspension and Steering</i>				
Suspension Joints	500 km	CV joints inspection		Replace in case of excessive freeplay
Suspension Arms +Tie rods	500 km	CV inspection		Replace in case of excessive freeplay
Hub Carriers	1000 km	CV inspection		Replace in case of excess of freeplay
Wheel Hubs and Bearings +Studs (welded)	500 km		Front 5000 km Rear 2000 km	Replace in case of excess of freeplay
Rear toe rod	500 km	Check if loose the stud on the hub carrier.		In case the stud is loose, replace with new bushing and new stud. In case of excessive free play between bushing and hub carrier replace both.
Dampers	500 km	CV inspection	5000 km	Overhauling service
Power Steering Fluid	5000 km		10000 km	
Steering rack			10000 km	
<i>Brakes</i>				
Front brake master cylinder			10000 km	Overhauling service
Rear brake master cylinder			10000 km	Overhauling service
Balance bar	2000 km	Clean and inspection	10000 km	Check often if the balance bar is working properly. Replace the circ clip in case the uniball goes off.

Description	Check Interval	Notes	Recommended replacement frequency	Notes
Calipers	5000 km (2000 km if used on severe tracks)	Check piston seals	10000 km	Send to Brembo for servicing
Flexible brake lines (caliper-chassis)	5000 km	Visual inspection of lines and connections.	10000 km	
Brake disk bell		Check at every discs replacement	5000 km	Replace nuts at every disc replacement
<i>Cooling systems</i>				
Water radiator	10000 km			
Gearbox oil radiator	10000 km			
<i>Fuel Tank</i>				
Refuelling hose	500 Km	Check leakage		
<i>Electronics</i>				
Wiring harness	End of Season			
Fuel pumps	End of Season			
<i>Fluids</i>				
Engine oil	500 Km	Level check	5000 Km	
Gearbox oil	1000 Km	Level check	5000 Km	
Gearbox F1 unit	1000 Km	Level check	5000 Km	
Power steering	1000 Km	Level check	5000 Km	Clean/wash the full circuit
Coolant	1000 Km	Level check	5000 Km	

4. Fluids & lubricants

Application	Brand	Type	Specifications	Replace interval
Power Steering Fluid	Shell	Donax TM	GM Allison C-4 ZF TE ML 09/12	5000 km, check level every 1000 km
Engine Coolant Fluid	Shell	Glycoshell	BS 6580 AFNOR NFR 15-601 ASTM D 3306	5000 km, check level every 2000 km
Engine Lubricant	Shell	Helix Ultra Racing 10w60	SAE 10W-60 API SJ/CF	5000 km, check level every 500 km
Brake Fluid	Brembo	LCF 600+		5000 km
Gearbox F1 & Clutch Fluid	Shell	Donax TX	ATF Dexron III ZF TE ML 14	5000 km, check level every 1000 km
Gearbox Lubricant	Pakelo	DLS - Racing		5000 km, check level every 2500 km
Driveshaft Grease	Castrol	Optitemp HT 1 - LF		
	Bechem	GKN HTBJ		

5. Dimensions and Weight

5.1. Dimensions

Description	Rules	Tolerance	Design (2016)
Overall length	Homol. Form.	± 5 mm	4991
Overall width	Homol. Form.	± 1 %	2096
Overall body width front wheel centerline	Homol. Form.	± 1 %	1962
Overall body width rear wheel centerline	Homol. Form.	± 1 %	1962
Wheelbase	Homol. Form.	± 10 mm	2942
Overhang front	Homol. Form.	± 10 mm	1038
Overhang rear	Homol. Form.	± 10 mm	1064
Front track	Homol. Form.	± 15 mm	1680
Rear track	Homol. Form.	± 15 mm	1630

5.2. Weight

The weight of the car as supplied may vary due to manufacturing tolerances.

The average minimum weight should not exceed 1410 kg in running order, without fuel and driver.

The minimum homologated weight depends on the sporting authority of the championship. The weight should be adjusted by the team by mean of appropriate ballast.

5.3. Ballast

Ballast should be fixed to the specific plate (P/N 082959700) installed in the front passenger place in the cockpit.

Maximum applicable ballast weight is 100 kg.

6. Engine

6.1. Engine specification

Engine Spec:

- Engine code: M145
- Engine type: V8 90°
- Displacement: 4692 cc
- 4 valves per cylinder.
- Wet sump / One Volumetric oil pump.
- 1 throttle, drive by wire control.
- 8 BOSCH injectors, 8 coils, multi-phased injection & ignition.

Otpimum upshift rpm :

- Gear shift at 7200 RPM in all gears.
- 7000 rpm, optimum rpm in VI gear continuously.
- Rev limiter at 7600 RPM in all gears.
- Gear shifting recommended at the first RED light.

Cooling system:

- Demineralised water (with pH >6.0) +20% glycol – quantity approx. 12.5 liters from a completely empty car and engine. Max level mark on water tank.
- Thermostat @ 86°C available for cold or night events.

Lubricating system:

- Oil type: see Table in 4 Fluids & lubricants.
- Minimum oil level in engine sump: 10 liters
- Maximum oil level in engine sump: 11.5 liters
- Total oil capacity from empty engine: 14.2 liters to have 11.5 liters in engine wet sump.
- For further details see below the oil level check procedure.

Exhaust system:

- One collector of 4 into 1, double exhaust manifolds - separate tubes - rigid assembly – rubber mountings on chassis.

Temperatures (**T1 = top speed straight line**) given for step 1 engine :

- Max temp. cooling fluid: 96°C in T1, 98°C max during a lap. Optimum 88 ÷ 91°C.

Electronic devices

- Engine ECU: Bosch Motronic ME 7.1.1.
- Gearbox ECU: Magneti Marelli CFC 301.
- Electronic gear box shifting control with two manual paddles at the wheel (gear up by right paddle, gear down by left paddle).
- Control dashboard with already programmed alarms available.
- Shift lights in top position directly incorporated into the dashboard case.

6.2. Maintenance procedures

6.2.1. First engine start up procedure

Follow this procedure if you are doing the first start of the day, after an engine or gearbox change, or after a maintenance work on cooling system or oil system.

1. First follow the 6.2.2 Oil level check procedure.
2. Be sure that the engine has got enough water and that there's fuel in the tank.
3. Connect a jump battery.
4. Turn on the car "MAIN" switch.
5. Wait 2 sec.
6. Turn on ignition switch
7. Push firmly the Start button until the Engine starts.
8. Pay attention, only after a complete pump out of fuel tank, if you want to run the engine (after refill of fuel) repeat twice time the procedure at point 6), because at first time the engine will not run.

6.2.2. Oil level check procedure

In order to have the exact check of the oil level, it's recommended the use of the specific tool shown in Picture 1. The procedure is the following:

- Condition of the test:
 - Cool engine ($15^{\circ} < \text{Water temperature} < 35^{\circ}$)
 - Wait at least 30 minutes since the switch off of the engine.
 - Car fixed and parked on an even surface on his 4 tires.

Picture 1. *Hollow cylinder.*

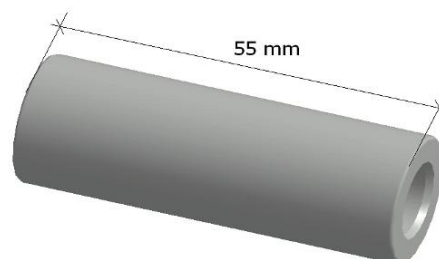

- Remove and clean the flexible stick

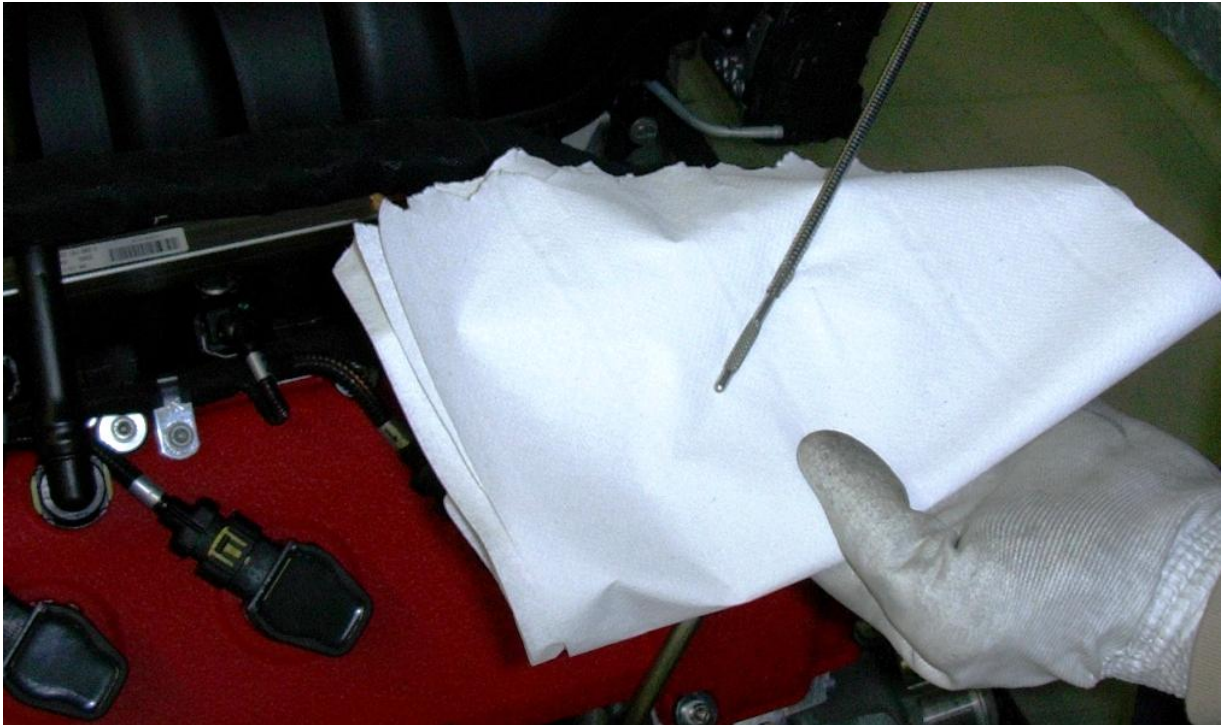

- Introduce the flexible stick into the hollow cylinder.



- Insert both components in the oil level check hose. Make sure to introduce slowly the flexible stick, especially when the hollow cylinder is close to check hose.



- Remove the flexible stick and keep it in the flat position in order to make a visual check. The nominal oil level recommend by Maserati is 11.0 Liters
See below the reference

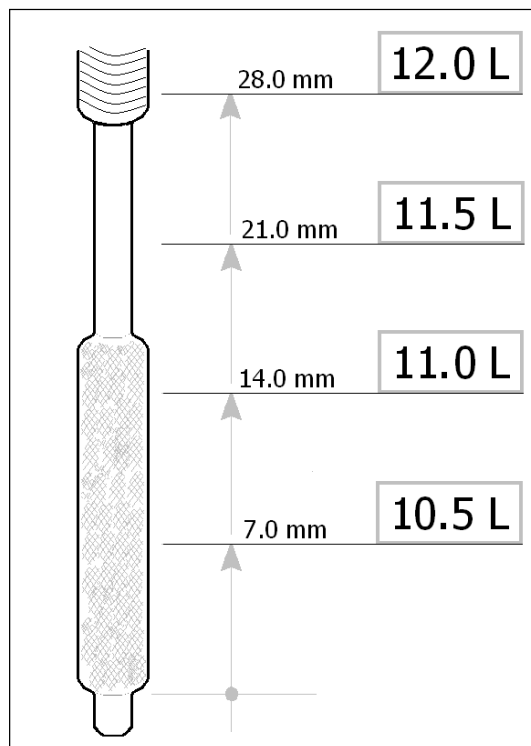

6.2.3. Engine auxiliary belt and water pump belt (check and replacement).

Follow this procedure every time you check or replace the engine auxiliary belt or the water pump belt.

Engine Auxiliary belt (only check):

- The procedure should be done only with the engine stopped and completely cool (Engine Water temperature \leq T_{Air environment}).
- Tension measuring by vibration control (Hz), in the point "A" shown below.

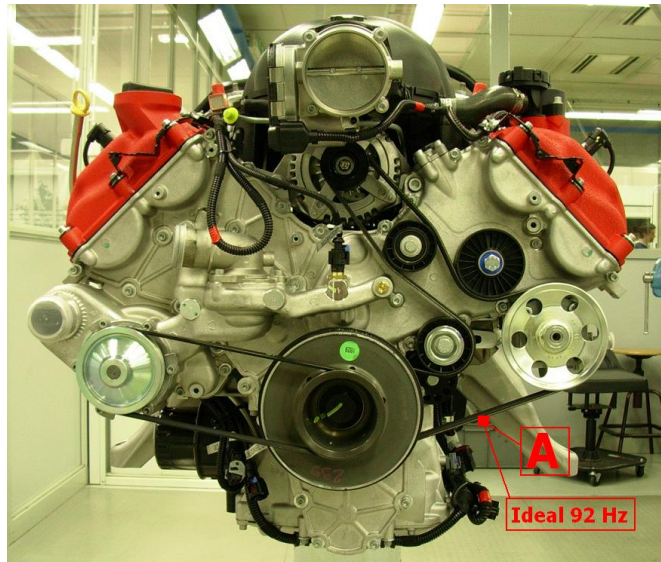

- In the picture below, a standard vibration measurement tool and a standard measurement procedure.
- The measurement must be done always after 2 complete manual crankshaft turns, in order to keep off residual tension of the rubber material.

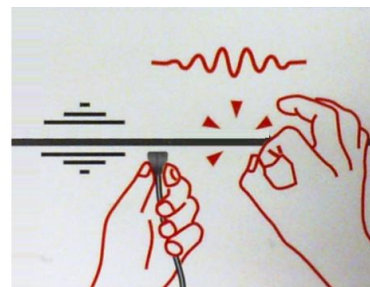

- Target values reported in the table below

Adjust if	Working range	Adjust if
A < 75 (Hz)	78 (Hz) < A < 110 (Hz)	A > 115 (Hz)

- The tension should be adjusted only with an accurate setting of the stretcher. Generally the position is fixed, but if the hole tolerance of the screw block is moved, you can have a good result of the setting. (details in the picture below)

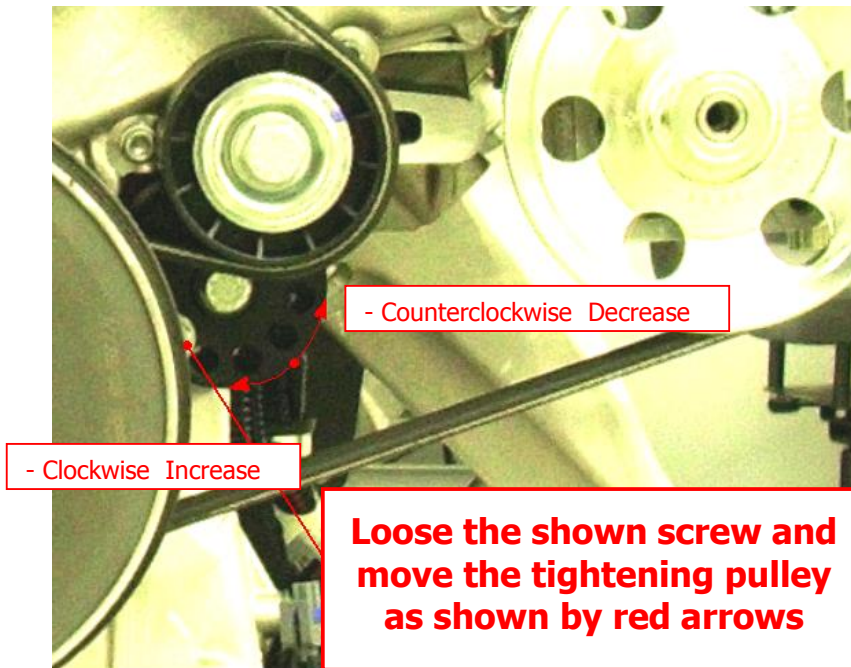

- Repeat the procedure after an engine belt replacement.

Water pump belt (Only replacement):

- The belt must be mounted or replaced by two synchronized operations, that is made by an helping hands during the manual crankshaft turning.

7. Transmission

7.1. Gearbox

The car is equipped with a 6 gear + reverse gearbox, with electro-hydraulic control.

7.1.1. Transmission Ratios

The transmission ratios are fixed and are shown in the following table.

<i>Gear</i>		<i>Input shaft</i>	<i>Output shaft</i>	<i>Gear Ratio</i>
		Z1	Z2	Z1/Z2
1st	14 / 45	14	45	0.311
2nd	20 / 41	20	41	0.488
3rd	23 / 33	23	33	0.697
4th	31 / 34	31	34	0.912
5th	31 / 28	31	28	1.107
6th	37 / 28	37	28	1.321
R	14 / 46	14	46	0.304
Bevel	11 / 46	11	46	0.239

The following diagram shows the speed vs. RPM relationship for the different gears, in two possible rear tyres configurations: 305/680/18 (old spec 2010, do not consider) and 325/705/18 (current spec, named Trofeo).

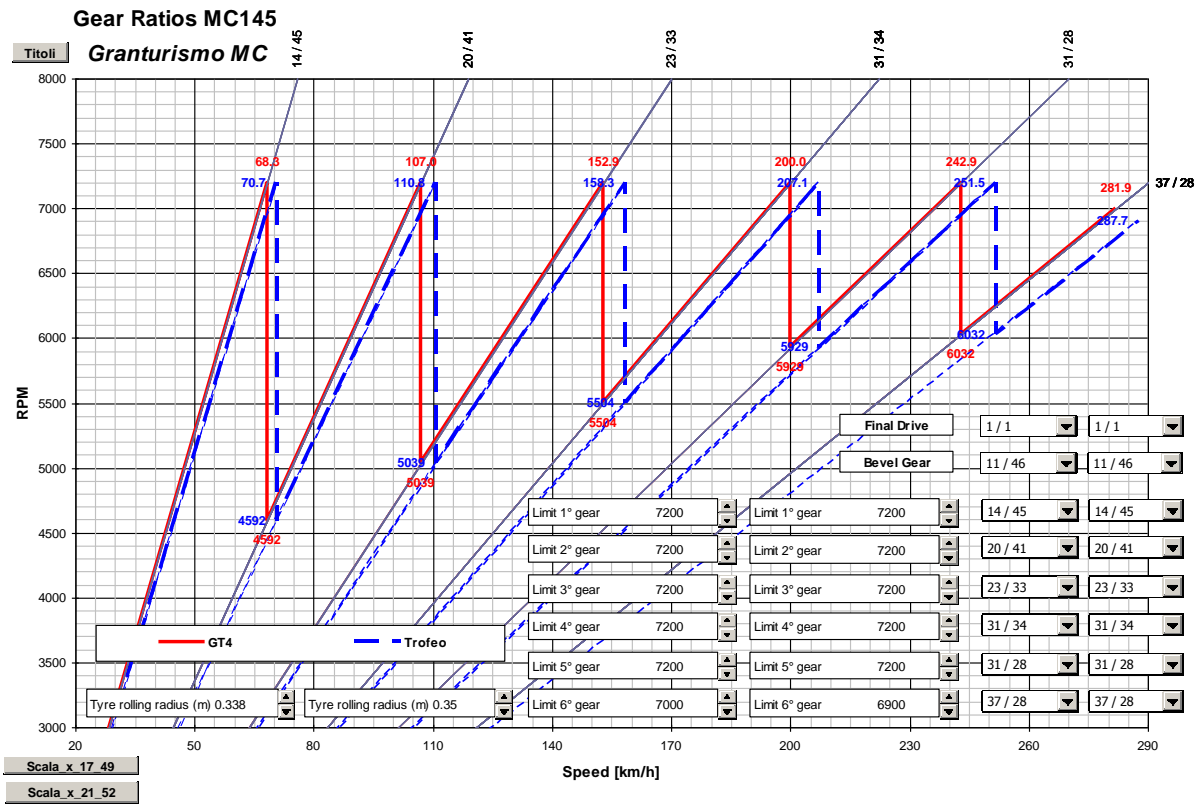

7.1.2. Oil level check procedure

The oil level of the gearbox may be checked through the specific inspection hole, shown in the following pictures.

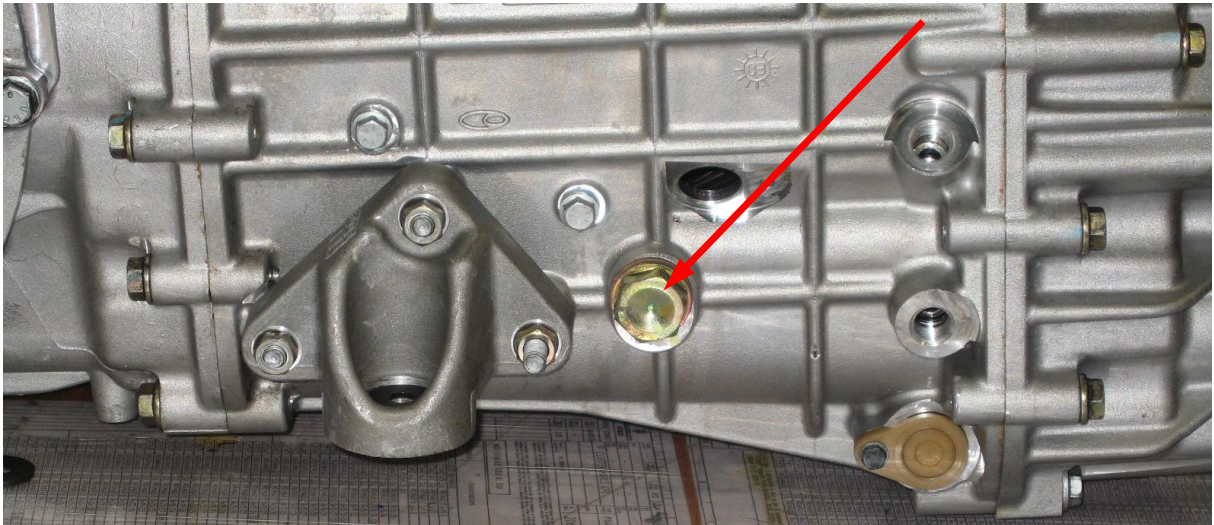
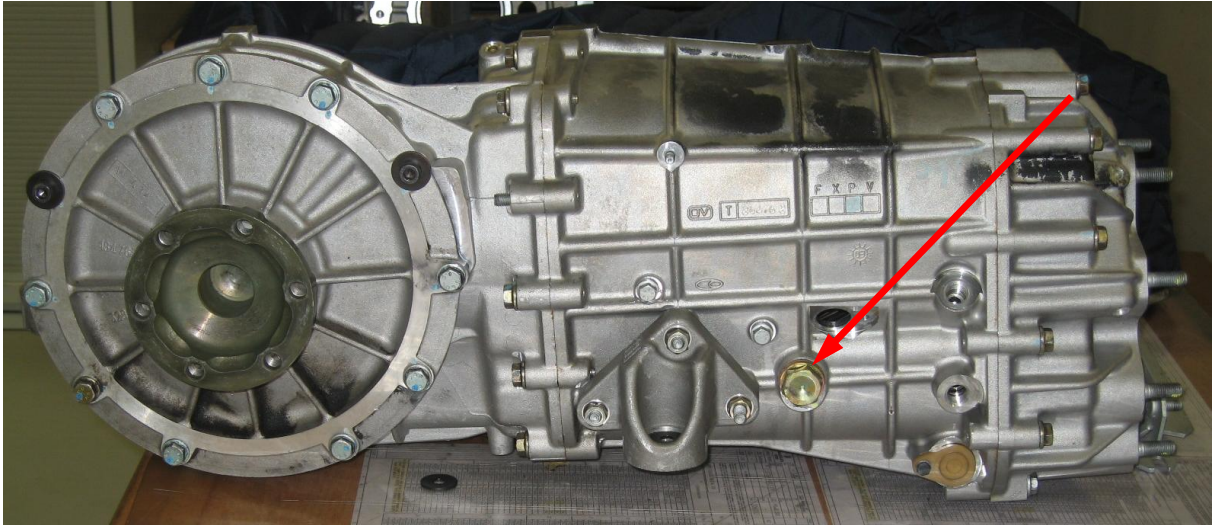

Unscrew and remove the cap. Check that the oil level reaches the inspection hole, with the car on a flat surface. If needed, oil can be added through the same hole, until reaching the level.

Oil can be added also by filling the gearbox catch tank, located in the luggage compartment, but the time required to actually flow into the gearbox is rather long, since it is connected to a breather (small hole).

7.2. Clutch

7.2.1. Clutch Replacement Procedure

To access the clutch, remove the complete clutch housing, together with the torque tube and the transmission shaft.

Loosen the clutch retaining screws.

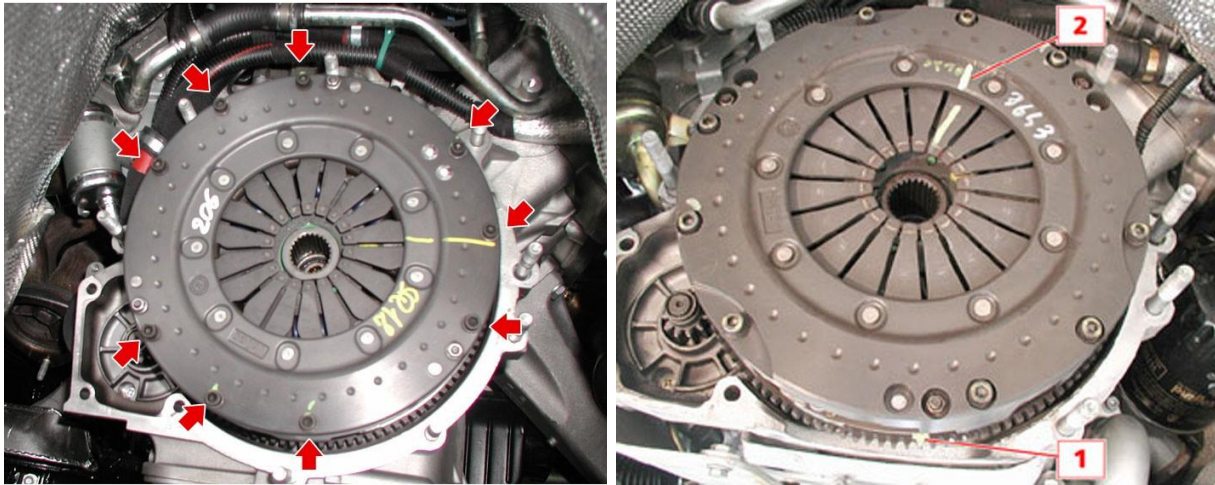

Rotate the engine flywheel manually, bringing the mark on the flywheel (1) (maximum flywheel unbalance position) opposite to the sign (2) (maximum clutch unbalance position) shown on the clutch. Position the centring shaft 900026250 on the clutch.



Remove the complete clutch.

Fit the clutch assembly in its seat on the flywheel using the clutch centring tool 900026250.

If refitting a clutch assembly which has been previously removed from the car, follow the markings made during removal.

The clutch disk is supplied by the manufacturer with the maximum unbalance point marked.

If fitting a new clutch disk, its maximum unbalance point must be positioned at 180° with respect to the maximum unbalance point of the flywheel.

Reinstall the complete housing with the torque tube and the transmission shaft.

IMPORTANT: after the replacement of the clutch, follow the procedures described at 7.3.1, 7.3.2, 7.3.3. to complete the clutch bleeding and the self setting gearbox procedures.

7.3. Gearbox Procedures

7.3.1. First gearbox start up procedure.

Follow this procedure before the start of the track activities on the first day or after any maintenance work on the gearbox or on the gearbox electronic related part.

- 1) Push the brake pedal, pull the right paddle on the wheel to engage the first gear.
- 2) Push the brake pedal, pull both paddles simultaneously, to shift into Neutral.
- 3) Push the brake pedal, push the white button at the bottom left side on the wheel to engage the reverse gear.

7.3.2. Air bleed procedure on the clutch actuator system.

Follow this procedure every time the clutch is replaced or the high pressure quick connect of the clutch actuator system is disconnected (first picture below).

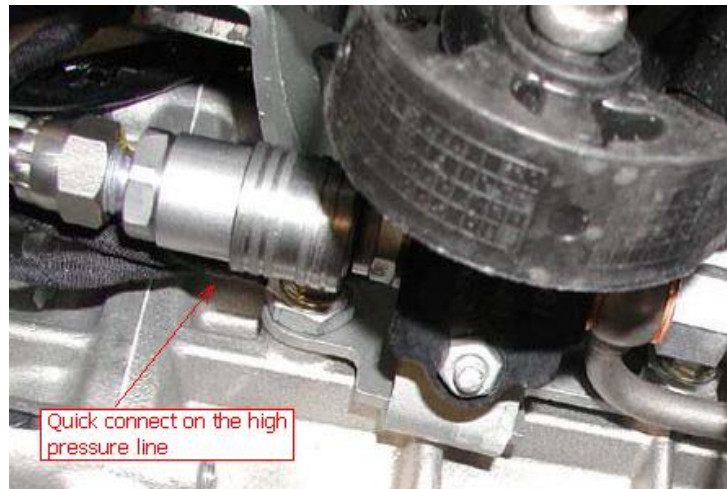

- Lift up the car, (minimum 50 cm from the ground), in order to have enough space to operate under the chassis.
- Insert a rubber pipe in the bleed connector (nipple) as shown in the picture below.



- Open the power unit cap tank and refill the tank of oil



- Connect to the OBD connector the "Diagnosis tool"

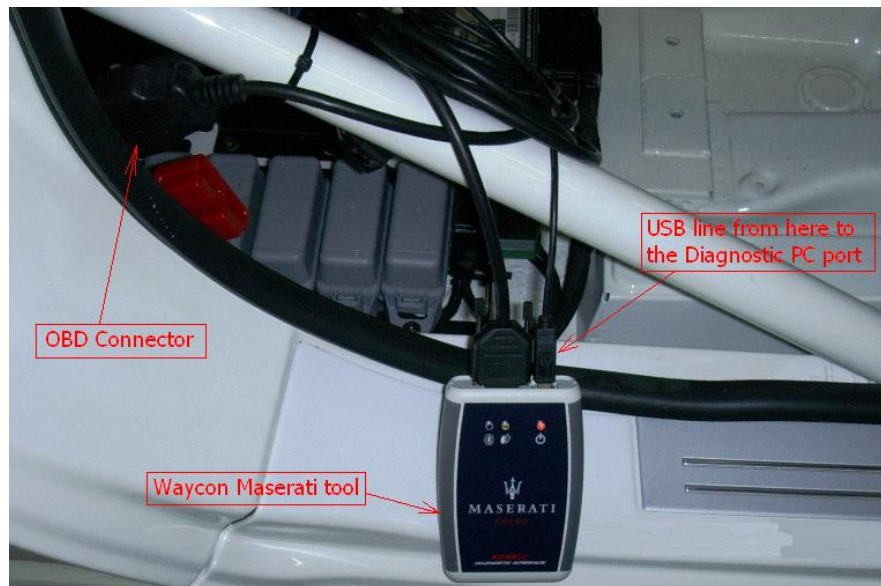

- Turn ON the car "MAIN" switch.
- Turn ON the ignition switch.
- Launch on the PC the Waycon diagnostic software. You can see below the icon of the software



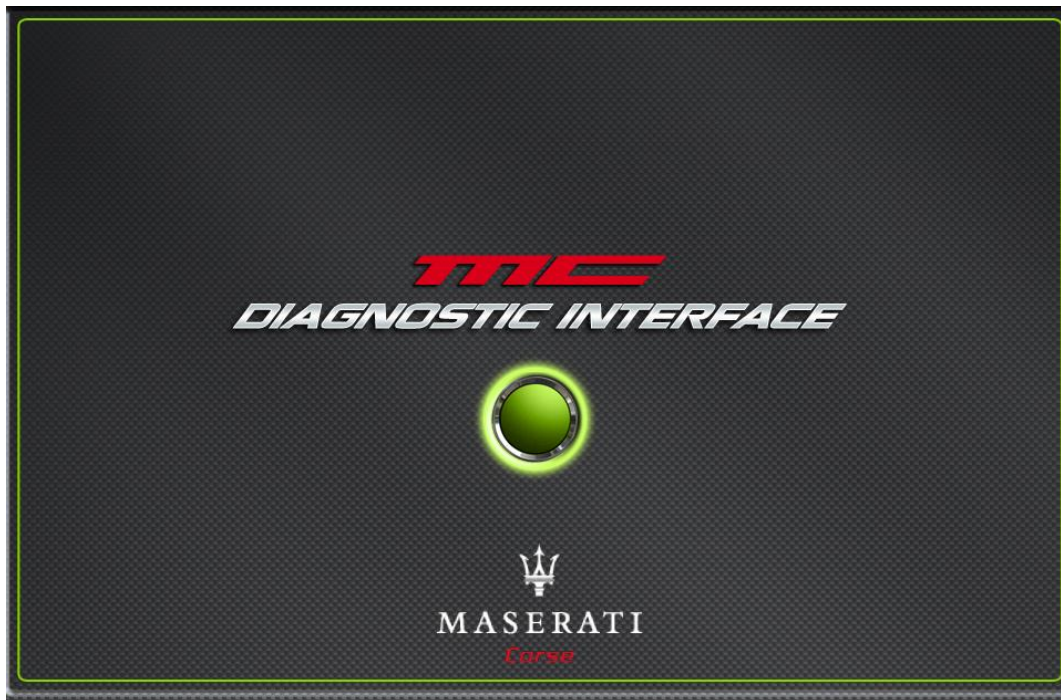

- Click on the green button



- Click on the "1" Grey Button "Esecuzione diagnosi"



- Click on Start Button

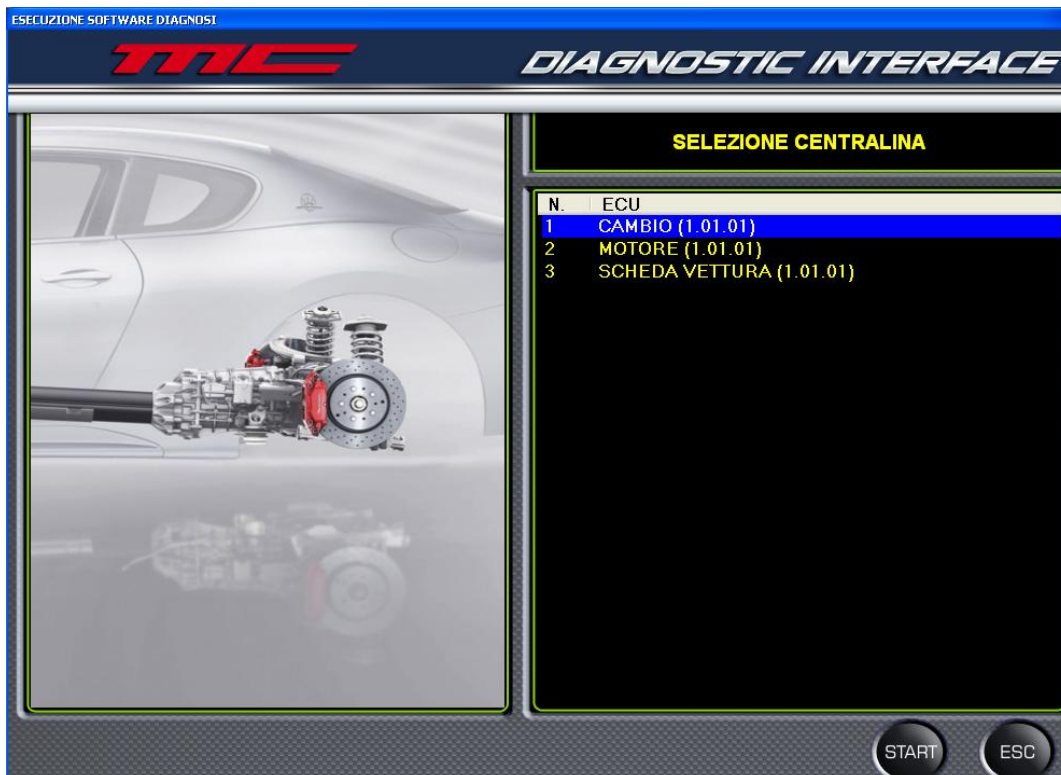

- Click on Start Button



- Select the line "Spurgo attuatore frizione" and click Start button.



- Before starting with the activation procedure, the PC user must advise the mechanic positioned under the car that he's about to start the procedure.
- Click "OK" button, when the pump will start running, the mechanic has to open the nipple to allow the air bleeding and then close the nipple when the actuator pump is still running. See the picture of the nipple below.



- Procedure sequence

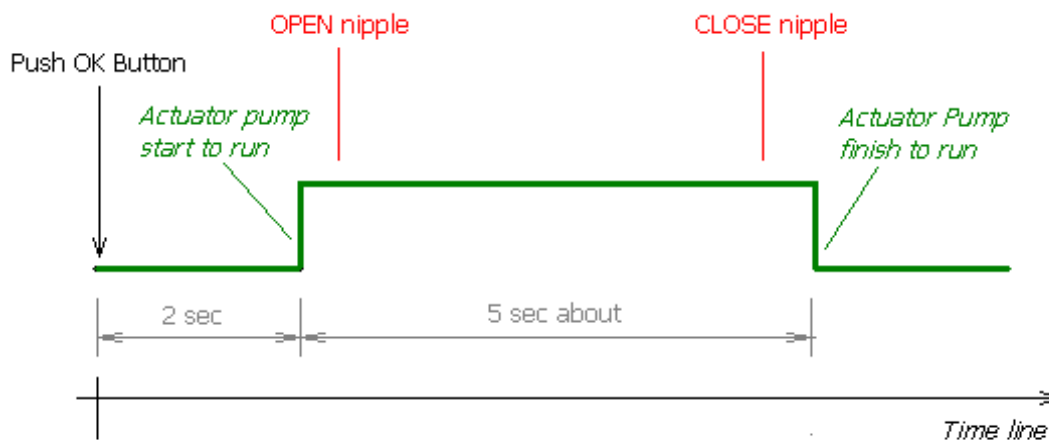

- Repeat three times the procedure described above.
- After this procedure you must strictly proceed with 7.3.3 procedure "Self setting gearbox procedure."

7.3.3. Self setting gearbox procedure.

Follow this procedure every time you replace the clutch, the gearbox or the gearbox TCU

- Connect the Diagnosis tool to the OBD connector

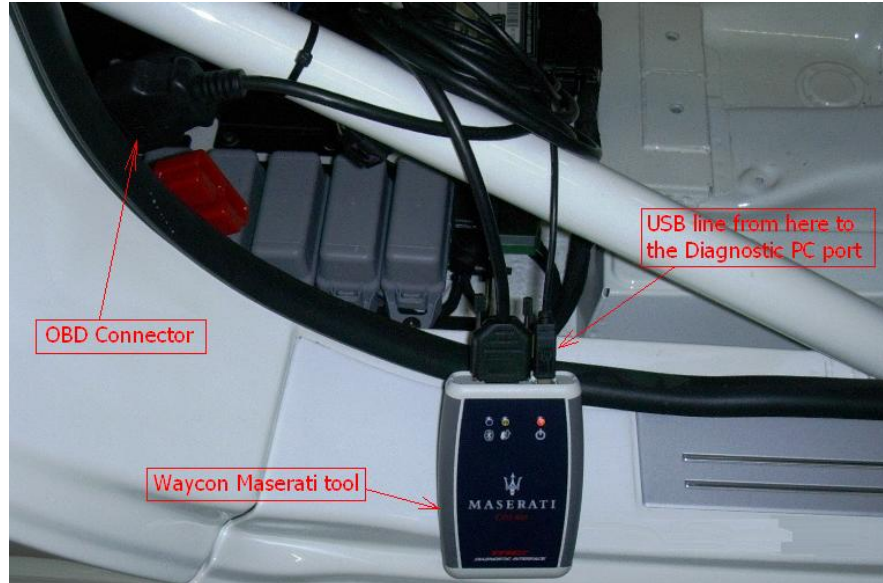

- Turn ON the car "MAIN" switch.
- Turn ON the ignition switch.
- Launch on the PC the Waycon diagnostic software.



- Click on the green button



- Click on the "1" Grey Button "Esecuzione diagnosi"



- Click the Start Button

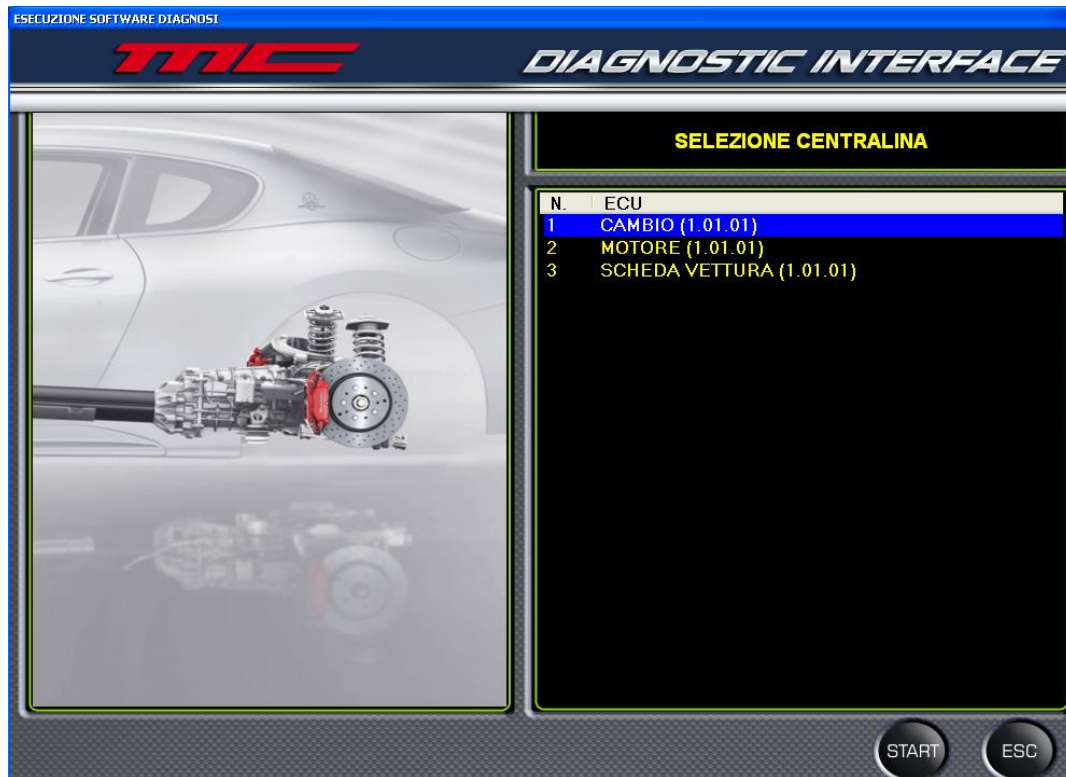

- Click the Start Button again



- Select the line "AUTOAPPRENDIMENTO DEIS" or "DEIS SELF LEARNING" (eng version) and click on Start.



- Click Ok. The procedure will take 4 to 8 minutes. If the procedure time is over 12/14 minutes, it need to be aborted and repeated again. It may happen to repeat the "1.2.4. Air bleed procedure" on the clutch actuator system, especially after the replacement of the clutch with a new part.
- The second part of the self setting procedure will be "AUTOAPPRENDIMENTO" or "SELF LEARNING" (eng version)



- Select AUTOAPPRENDIMENTO or "SELF LEARNING" (eng version) and click on Start.



- Click Ok. After 2 sec, the gearbox engages all gears automatically. It's recommended to slightly move back and forth the car in order to help the gearbox in the engagement of gears.

The third part of the self setting will be "AUTOAPPRENDIMENTO CAMBIATA VELOCE" or "FAST SHIFT SELF LEARNING" (eng version)



- Select "AUTOAPPRENDIMENTO CAMBIATA VELOCE" or "FAST SHIFT SELF LEARNING" (Eng version).



- Click Ok. After 2 sec the gearbox starts to engage all gears automatically.
- At the end of this procedure:
 - Turn OFF the ignition switch.
 - Turn OFF the car "MAIN" switch.
 - Wait minimum 20 sec
 - Turn ON the car "MAIN" switch.
 - Turn ON the ignition switch and the car will be ready to run.

8. Brakes

8.1. Calipers

The car is equipped with Brembo racing calipers.

Do not use solvents or chemicals to clean the brake calipers, but water and soap.

Chemical aggression/corrosion may result in permanent damage to the pistons and/or the seals, with consequent fluid leakage and/or air penetration.

8.1.1. Front Caliper

Brembo **P6 28/30/38**, Ref. **XA6.61.01** (left), **XA6.61.02** (right).

6 piston caliper: diameters 28mm, 30mm, 38mm

8.1.2. Rear Caliper

Brembo **P4 30/34**, Ref. **XA7.G1.13** (left), **XA7.G1.14** (right).

4 piston caliper: diameters 30mm, 34mm

8.1.3. Tightening torques

Tightening torques of bleeding nipples:

- Cold brakes: **12 ÷ 16 Nm**
- Hot brakes: **8 ÷ 10 Nm**

Tightening torque of the brake line fitting to caliper with copper seal is **23 ÷ 26 Nm**.

Tightening torque of calipers to the hub carrier is

- Front Caliper **65 ÷ 75 Nm**
- Rear Caliper **45 ÷ 55 Nm**

8.2. Brake Disks

The car is equipped with steel brake disks

	Maserati Part Number	Brembo Part Number	Outside Diameter	Thickness
Front - LH	205096	09.8528.78	380 mm	35 mm
Front - RH	205097	09.8528.88	380 mm	35 mm
Rear - LH	261802	09.A882.10	326 mm	26 mm
Rear - RH	261801	09.A882.20	326 mm	26 mm

Maximum recommended wear of the disks is 1 mm, resulting in minimum thickness 34 mm for the front disks and 25 mm for the rear disks.

8.2.1. Tightening torques

Tightening torques of the pegs for connecting the brake disk to the bell is **10 ÷ 12 Nm** and should be checked always with cold brakes.

8.3. Brake Pads

The car is equipped with the following brake pads (**RB170**)

	Maserati Part Number	Brembo Part Number	Thickness	Recommended wear (min. thk.)
Front	259260	B24.25.170	25 mm	< 15 mm (10 mm)
Rear	259261	B24.20.170	20 mm	< 10 mm (10 mm)

NOTE: New Brake pads fitting

When installing the new front brake pads, smooth the surface on the side of the caliper bridge (see picture below), in order to avoid any interference with it.

It is enough to remove the red colour paint on that area.

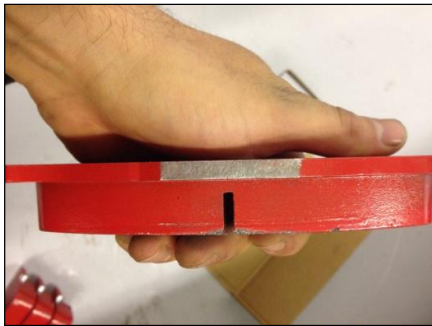

8.4. Pedal box with balance bar

The GranTurismo MC is equipped with a racing specific pedal box with two master cylinders and a balance bar.

The standard brake balance is set to 50 bar front/40 bar rear, easy adjustable by looking at the pressure values displayed on the right side of the dashboard, when pushing on the brake pedal.

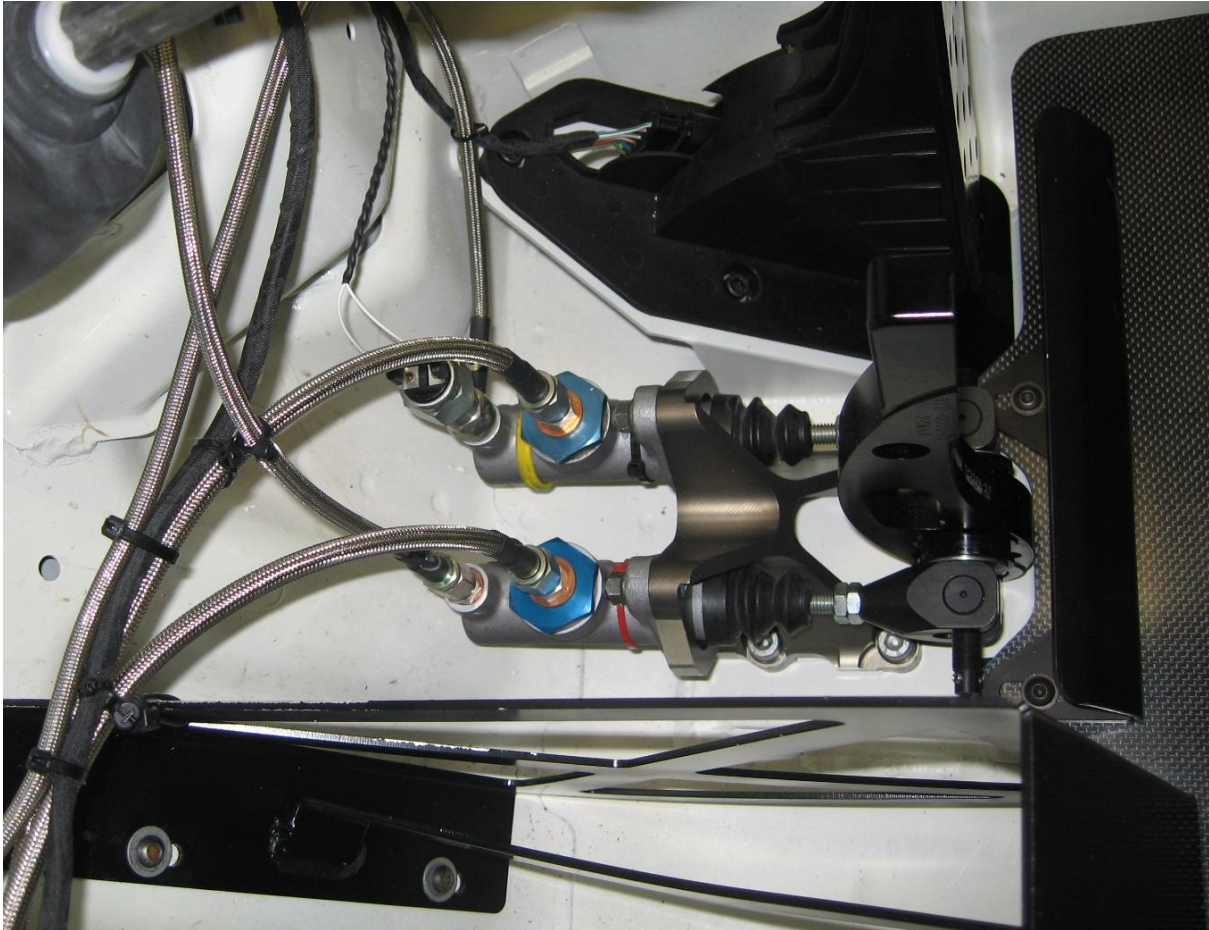

8.4.1. Master cylinders

Standard equipment

- FRONT Ø16.8 mm (right side)
- REAR Ø22.2 mm (left side)

The use of master cylinder with a different diameter is subject to the approval from the series promoter.

Alternative options:

- FRONT Ø 15.0 mm / 15.9 mm / 16.8 mm / 17.8 mm
- REAR Ø 19.1 mm / 20.6 mm / 22.2 mm / 23.8 mm

8.4.2. Brake Fluid Tanks

The brake fluid tanks are installed in the engine compartment. The heat protection shield shown in the picture is recommended.

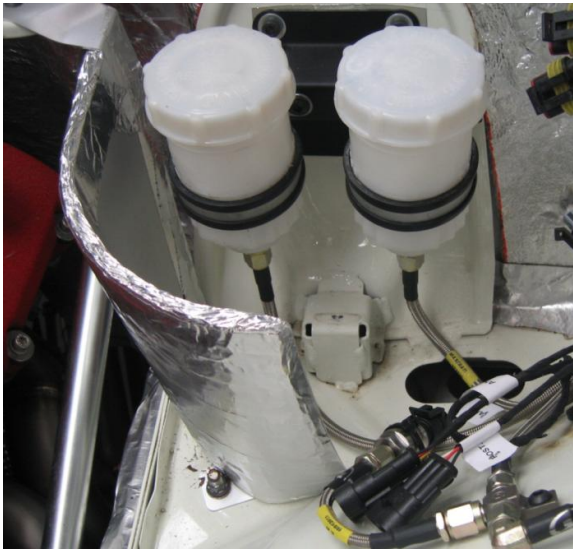

8.4.3. Balance Bar

The balance bar should be adjusted following the attached drawing:

MAXIMUM ARTICULATION +/- 20°

IN CASE OF ONE CIRCUIT FAILURE, MAXIMUM TRAVEL BEFORE BRAKING IS 12.2 MM ON BALANCE BAR

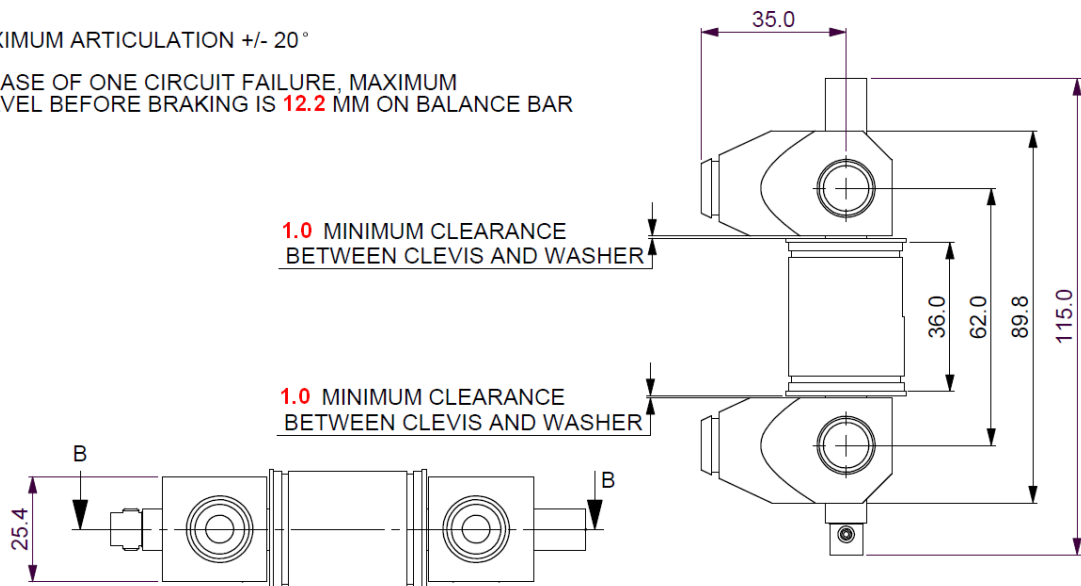

The values written in red have been changed from the original specification from the manufacturer.

Important note: adjust the pushrods of the master cylinders so that the balance bar is perpendicular to the pushrods under maximum load. The system is then square. It is not important that the system is square when released, but it has to be under load.

8.4.4. Balance knob

The balance knob is located on the central console, as shown in the picture.



The brake balance can be modified by turning the knob as follows:



- **CLOCKWISE** TO CHANGE THE BRAKE BALANCE TO THE FRONT AXLE
- **ANTI-CLOCKWISE** TO CHANGE THE BRAKE BALANCE TO THE REAR AXLE

NOTE

The modification of the original setting (50 ANT / 40 POST) MUST BE DONE EXCLUSIVELY with the brake pedal fully released (also if the car is moving).

9. Setup

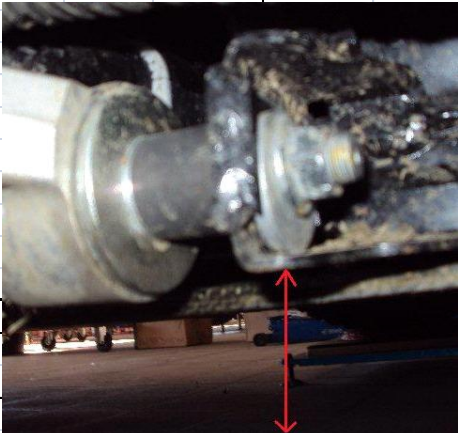
9.1. Standard Setup (Ref. Trofeo car 2015 spec)

Setup Sheet										
Event							Driver			
Circuit							Chassis			
Date							Engine	Fuel		
	FRONT					REAR				
Ride Height (mm)	Aero	Splitter 2014 (52 mm min ride height)				Aero	Diffuser spec 2015			
							Rear wing: hole B + nolder 10mm			
F	84 (236)*	Spring	260 N/mm				Spring	170 N/mm		
R	156 (150)*	Bump stop	Sachs std+12 mm packer+3 mm packer				Bump stop	Sachs std+10 mm packer		
NOTES	ARB	Serie AR8C				ARB	25 x1,5			
Damper	Sachs Set MAS 2					Sachs Set MAS 3				
Damper setting	REBOUND	LO - HI / LO - HI			BUMP	REBOUND	LO - HI / LO - HI			BUMP
	not adjustable					not adjustable				
Toe	-2.0 mm per single wheel (open)					2.0 mm per single wheel (closed)				
Camber	-3°45'±15'					-3°15'±15'				
Geometry	STD					STD				
Caster	4°									
Wheels	11x18					13x18				
Tyres	Pirelli 305/680/18					Pirelli 325/705/18				
Brakes	Discs	Brembo				Brembo				
	Pads	RB170				RB170				
	M/Cyl.	16,8				22,2				
	Blanking	no				no				
	Balance	50				40				
Gear Ratios	1	2	3	4	5	6	Bevel	Final	Differential	
	14/45	20/41	23/33	31/34	31/28	37/28	11/46	-	Standard	
Engine RPM Limit	7500	7500	7500	7400	7300	7100				
Notes	<p>*Ride height measurement: Front: mm measurement on lower front profile front subframe (equal to 236 mm spring platform) Rear: mm measured on the circular profile fixing point rear subframe (equal to 150 mm spring platform)</p>									
										

9.2. Setup Adjustment

9.2.1. Ride Height Adjustment

Front		Rear	
Adjustment	Change	Adjustment	Change
1/6 TURN on shock ring	0.34 mm	1/6 TURN on shock ring	0.29 mm
1 TURN on shock ring	2.05 mm	1 TURN on shock ring	1.72 mm

Shock absorber ring thread pitch is 1.5 mm

9.2.2. Ride Height Important Note

Minimum recommended rear ride height is **113 mm on Trofeo spec tyres**.

A lower ride height may result in driveshaft damage (excessive angles).

9.2.3. Caster Check

The nominal caster angle is 5.2°. It may be checked by mean of a standard electronic setup bench for road cars. It is recommended not to modify it, unless extreme deviation (> 2°) from the nominal is found.

Adjustment could only be done by changing the spacers distribution on the suspension joints.

9.2.4. Camber Adjustment

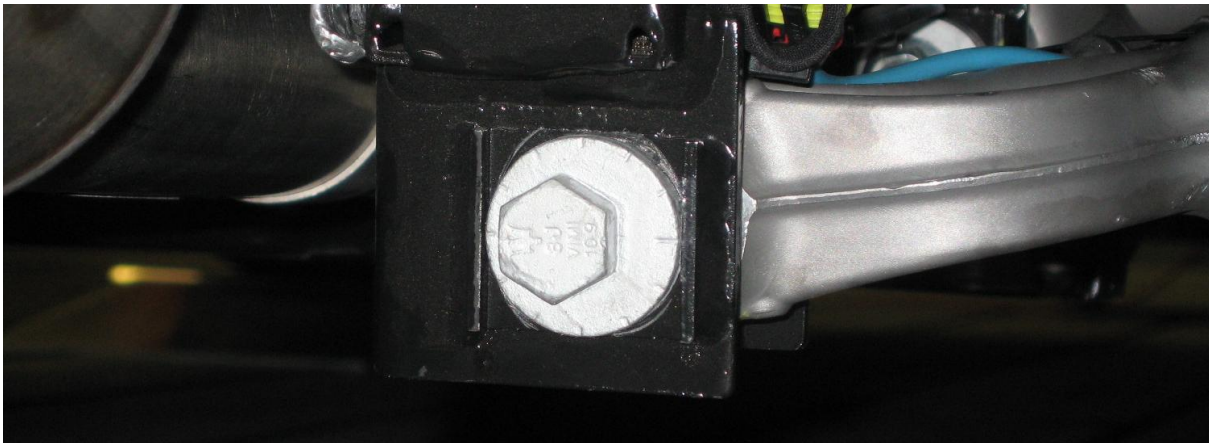

The wheel camber angle may be adjusted by moving the lower pivot points of the lower arm. This is done by adjusting the cam-shaped bolts of the pivots. Remember to always adjust the 2 cam-shaped bolts of the same arm in the same position, to avoid bending stress and hysteresis on the suspension.

The following table is referred to the right suspension viewed from the rear or the left suspension viewed from the front. The *angle* is the rotation angle of the cam-shaped bolt,

the 0° being the position where the bolt head (and the stem) is fully out and 180° being the position where it is fully in.

The camber angle values are theoretical values, but because of the manufacturing tolerances the actual values may differ up to $\pm 0.25^\circ$.

Camber adjustment entails unwanted toe change, see 9.2.6 Toe restoration after camber adjustment

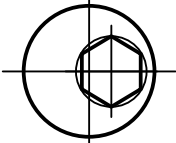
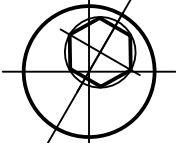
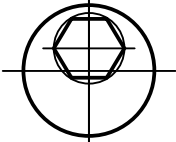
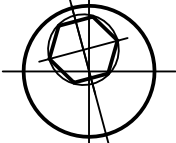
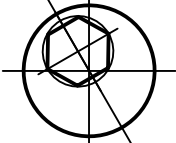
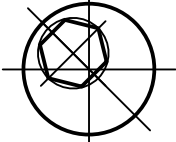
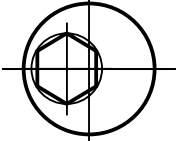
Position	Angle [°]	Camber [°] (decimal)	
		Front	Rear
	0°	-4.25	-3.75
	45°	-4.0	-3.5
	60°	-3.9	-3.4
	75°	-3.7	-3.2
	90°	-3.50	-3
	105°	-3.3	-2.8
	120°	-3.1	-2.6
	135°	-3.0	-2.5
	180°	-2.75	-2.25

9.2.5. Toe Adjustment

Steering link for the front and toe link for the rear are adjustable via a threaded sleeve to allow for toe adjustment.

The standard setup values mentioned in the setup sheets are measured as a difference in Y position of the rear rim edge to the front rim edge of one wheel. Negative values are for toe out, positive for toe in.

It is recommended to adjust the toe, possibly on a setup plane, and with the proper toe measurement tool.

However, should an adjustment be done without the possibility to check properly the values, the following table shows the calculated relationship between the adjustment applied and the resulting change.

Front Toe (Single Wheel)		Rear Toe (Single Wheel)	
<i>Adjustment</i>	<i>Change</i>	<i>Adjustment</i>	<i>Change</i>
1 barrel FLAT on steering link	0.86 mm	1 barrel FLAT on toe link	-1.37 mm
1 barrel TURN on steering link	5.18 mm	1 barrel TURN on toe link	-8.20 mm

The steering link is in front of the steering (king-pin) axle and it is adjusted on the hub side only. The thread pitch is 1.5 mm, thus one turn means 1.5 mm change in length. Screwing in the thread (shortening the link) entails a positive change (toe in).

The toe link is back of the (virtual) steering axle of the rear suspension. It is adjusted by mean of 2 opposite threads: the one on the hub side is right-hand-threaded and 1.5 mm of pitch, the other is left-hand-threaded and 1.0 mm of pitch, thus one turn means 2.5 mm change in length. Screwing in the thread (shortening the link) entails a negative change (toe out).

9.2.6. Toe restoration after camber adjustment

Camber adjustments entail unwanted toe changes. It is recommended to make adjustments on a setup plane and with the proper toe measurement tool.

However, should an adjustment be done without the possibility to check properly the values, the following table shows the calculated relationship between the adjustment applied and the resulting change.

Front Camber			Rear Camber		
<i>Adjustment</i>	<i>Toe Change</i>	<i>Restoration</i>	<i>Adjustment</i>	<i>Toe Change</i>	<i>Restoration</i>
-0.25°	1.52 mm	-1 ¾ FLATs	-0.25°	-1.47	-1 FLAT
-0.75°	5.16 mm	-1 TURN	-0.75°	-5.02	-3 2/3 FLAT

As above the link adjustment is considered positive when screwing in (shortening).

9.3. Kinematics

NOTE: the following charts of the theoretical kinematic behaviour of suspensions refer to the 2010/2011 Trofeo car specification, without the 25 mm spacers on the wheel hub. Positive wheel travel = bump.

9.3.1. Toe vs Wheel Travel (Positive = Toe In)

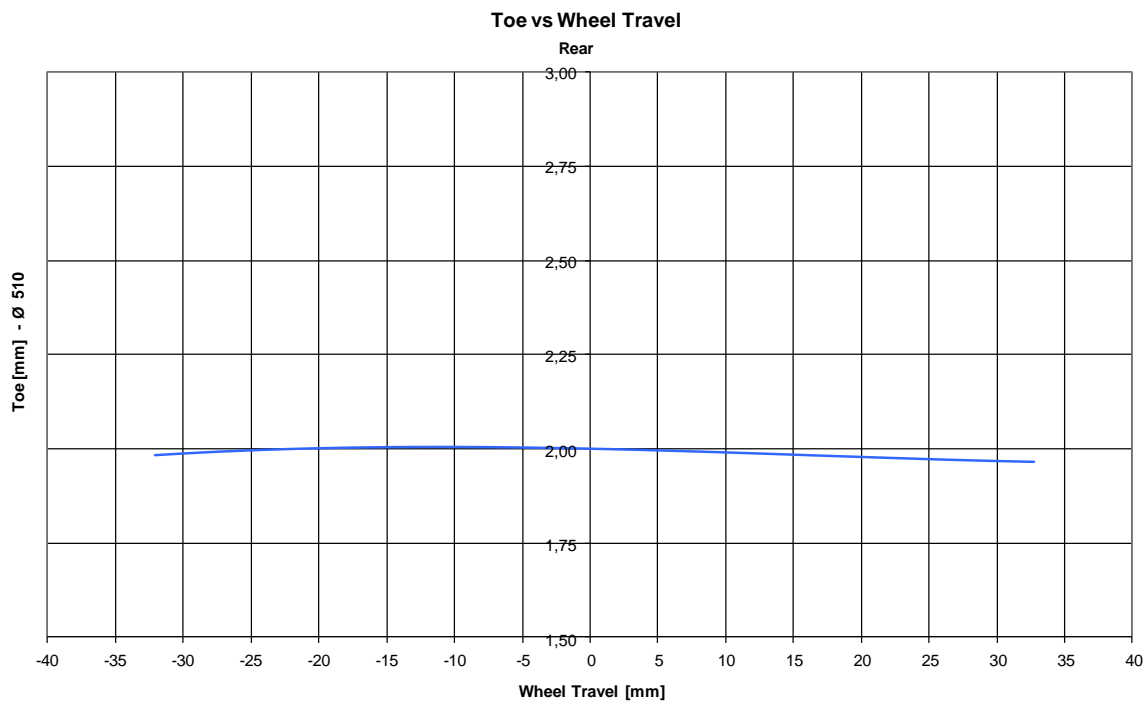
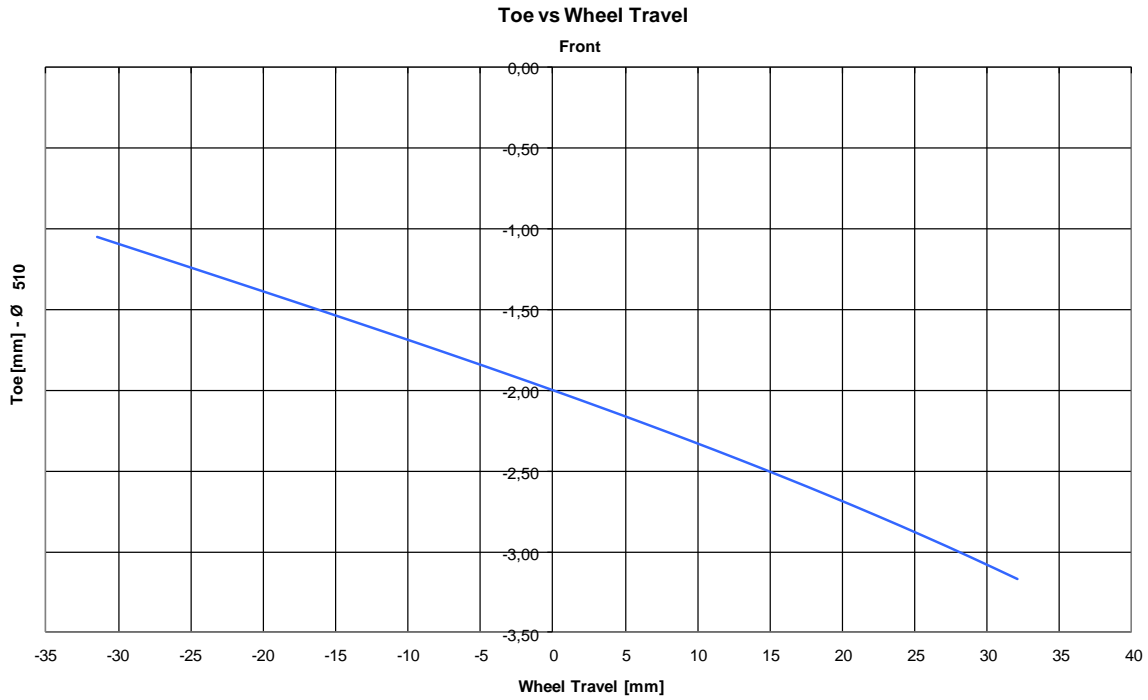

9.3.2. Camber vs Wheel Travel (Positive = Toe Out)



9.3.3. Caster vs Wheel Travel

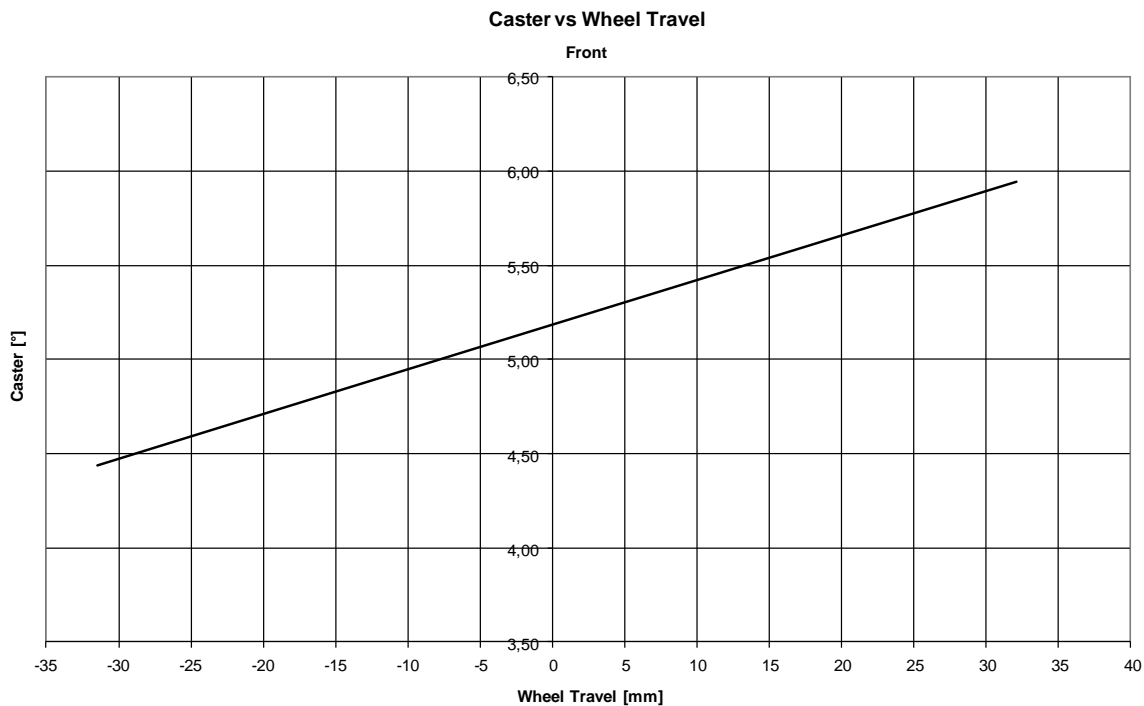

9.3.4. King Pin vs Wheel Travel

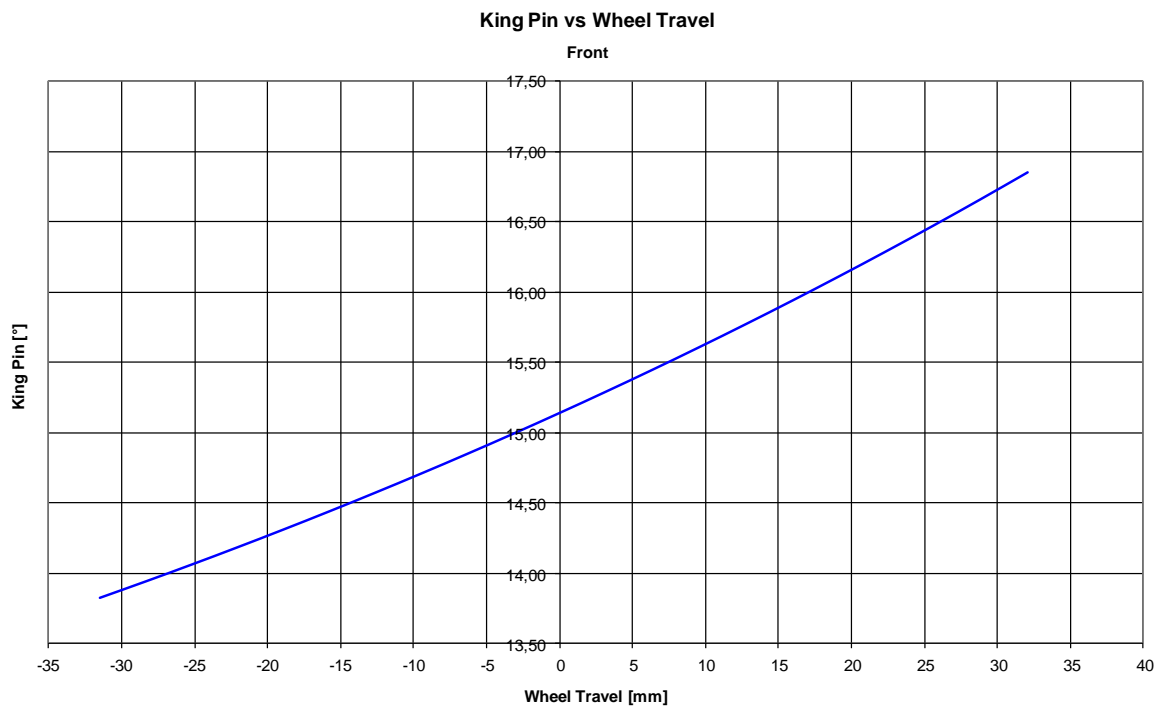

9.3.5. Half-Track vs Wheel Travel

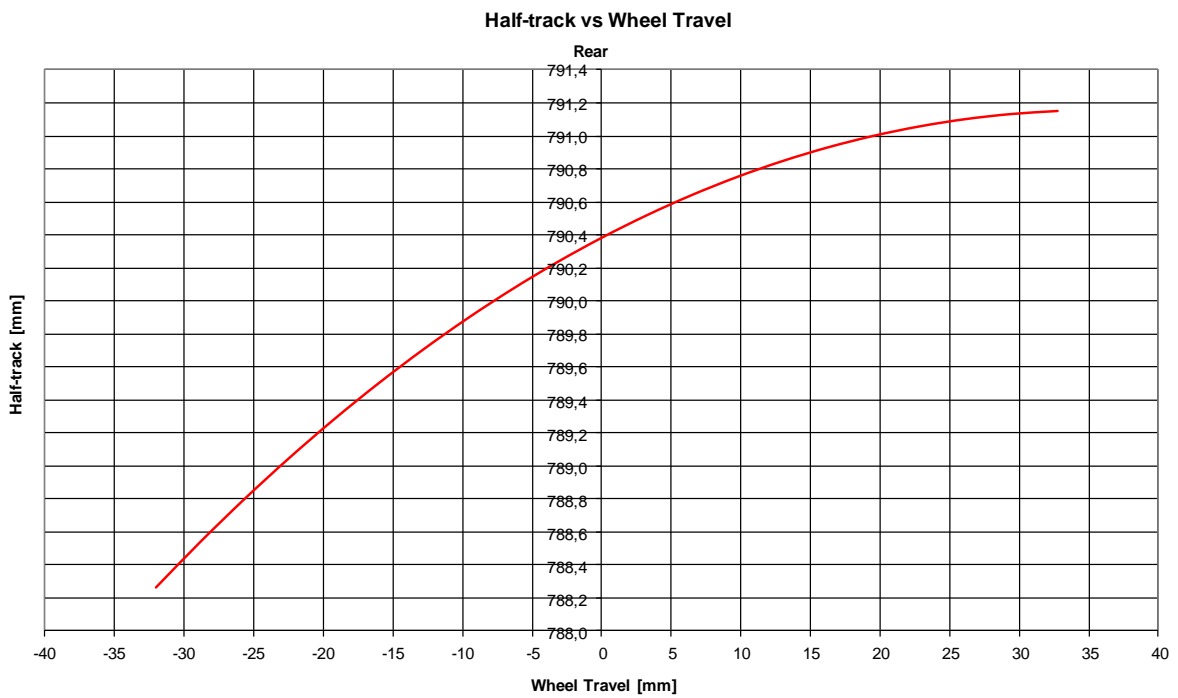
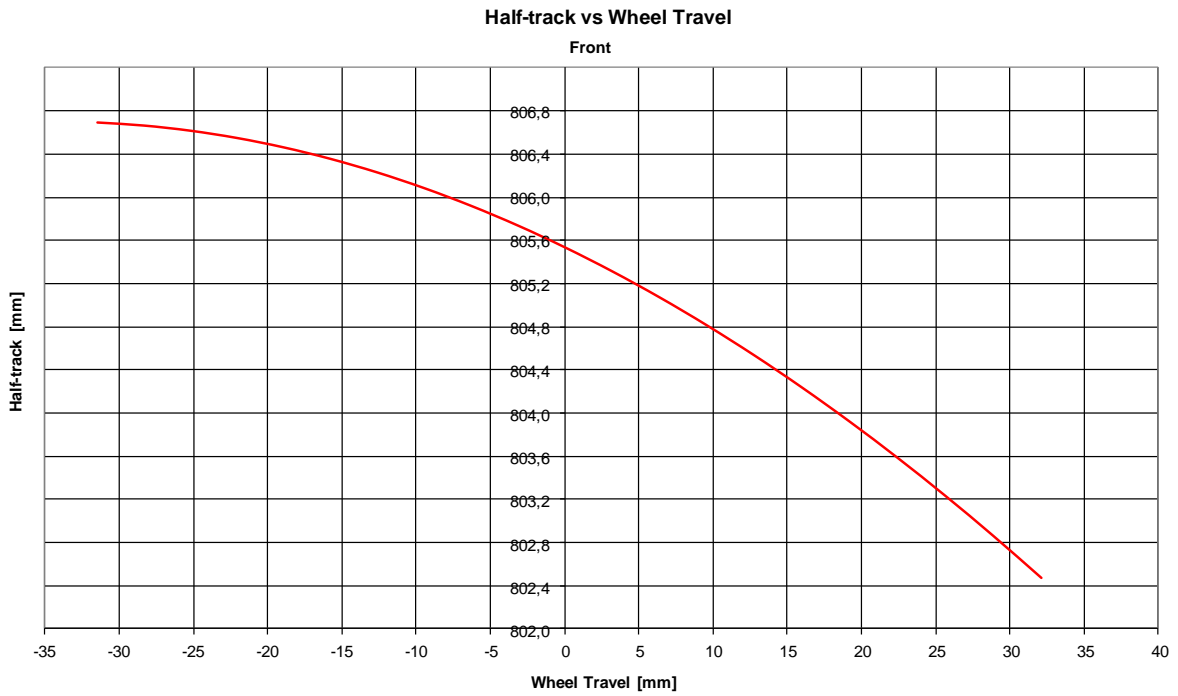

9.3.6. Wheel / Spring Ratio vs Wheel Travel

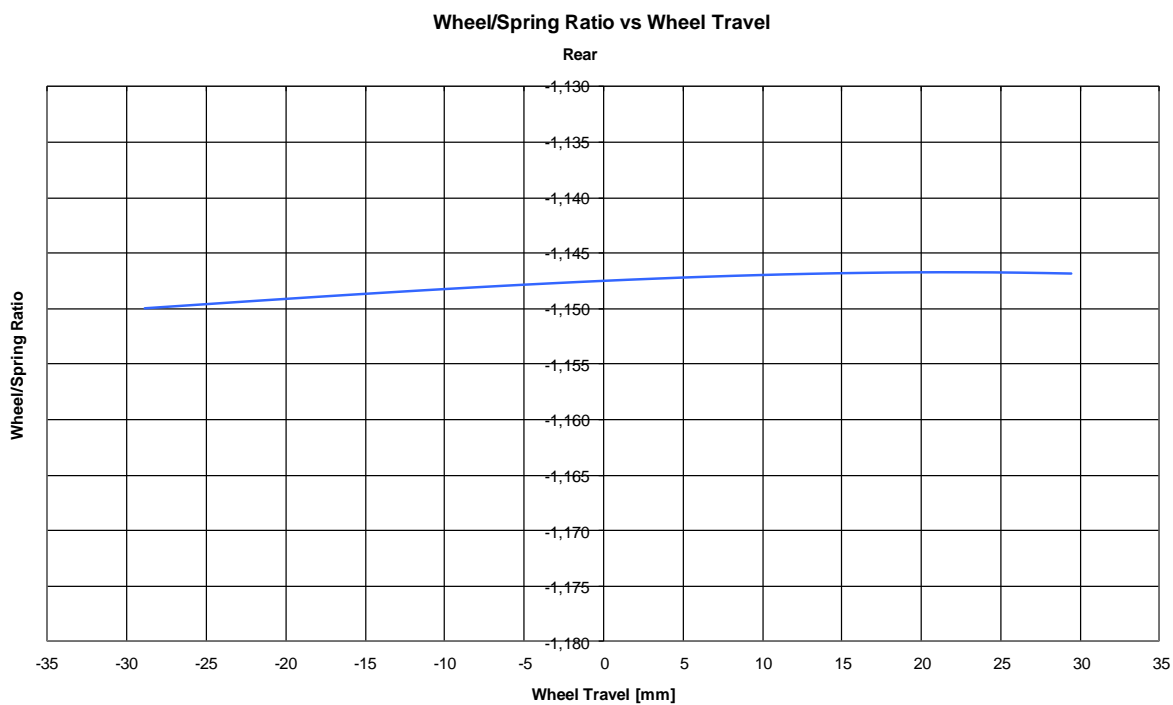
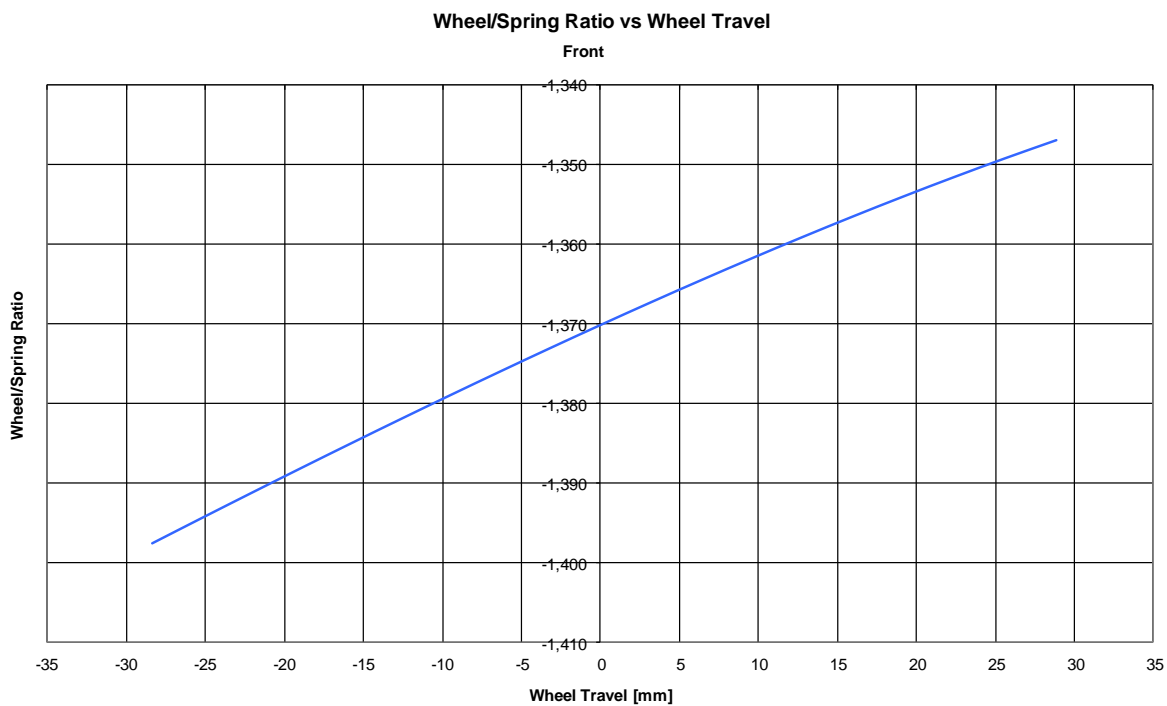

9.3.7. Wheel / ARB Ratio vs Wheel Travel

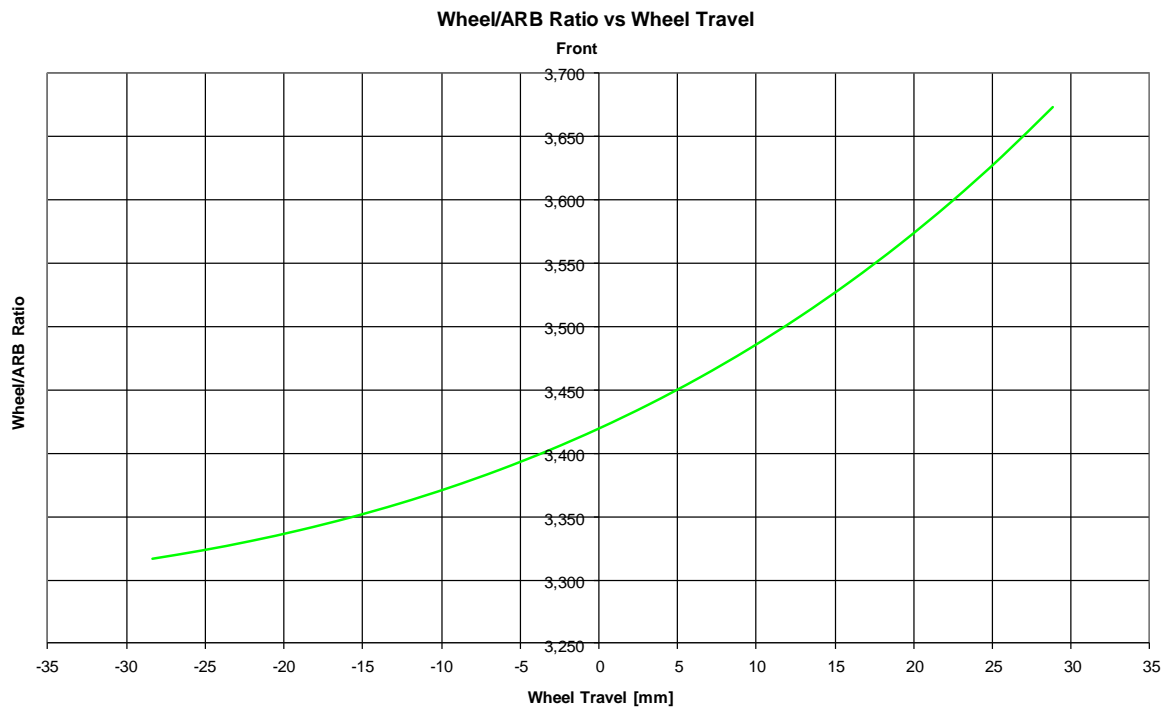

9.3.8. Roll Centre Height vs Wheel Travel

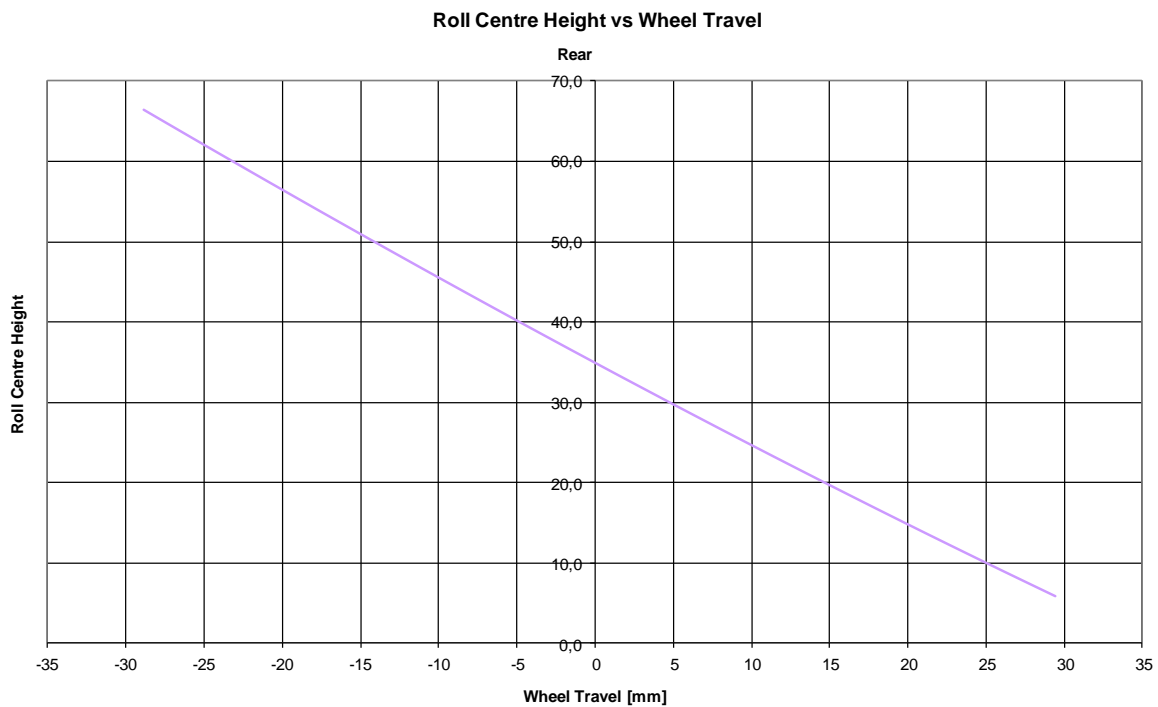
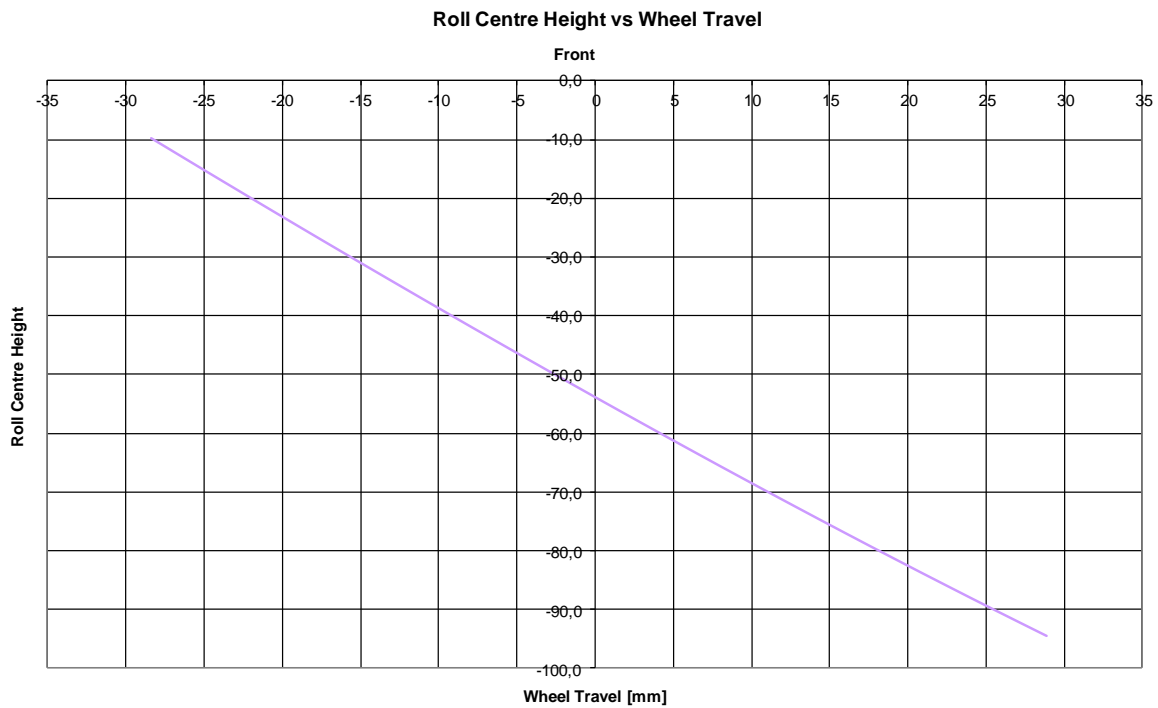

9.3.9. Antidive vs Wheel Travel

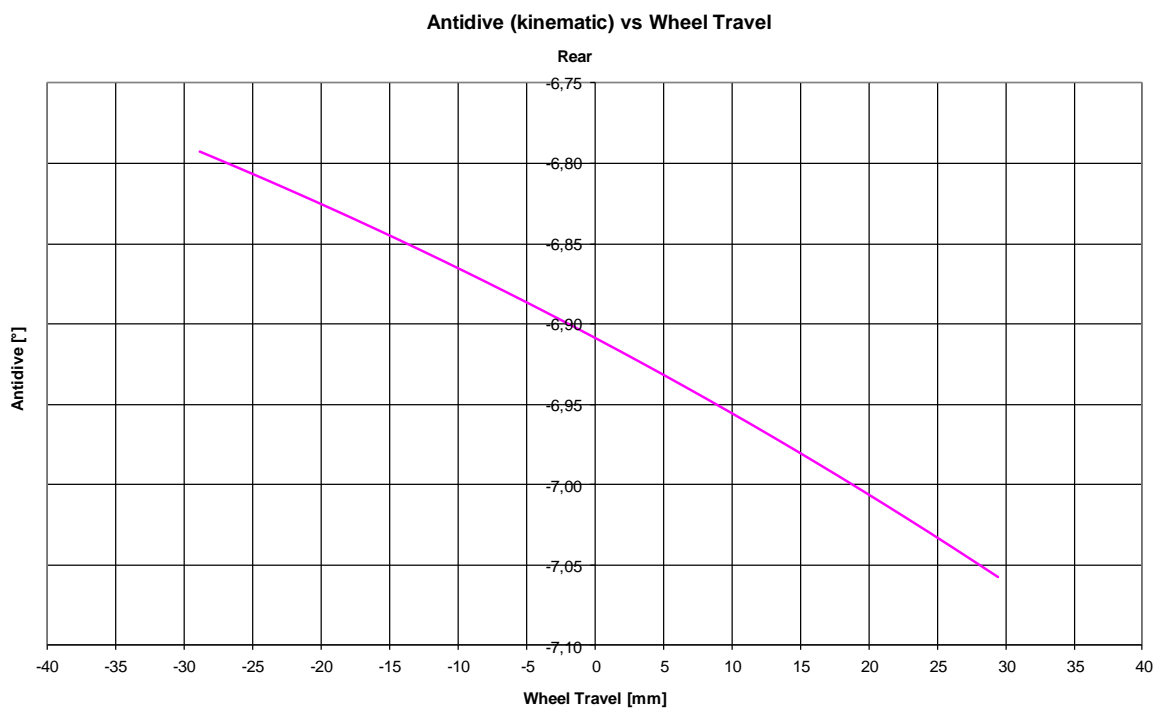

Antidive (dynamic) vs Wheel Travel

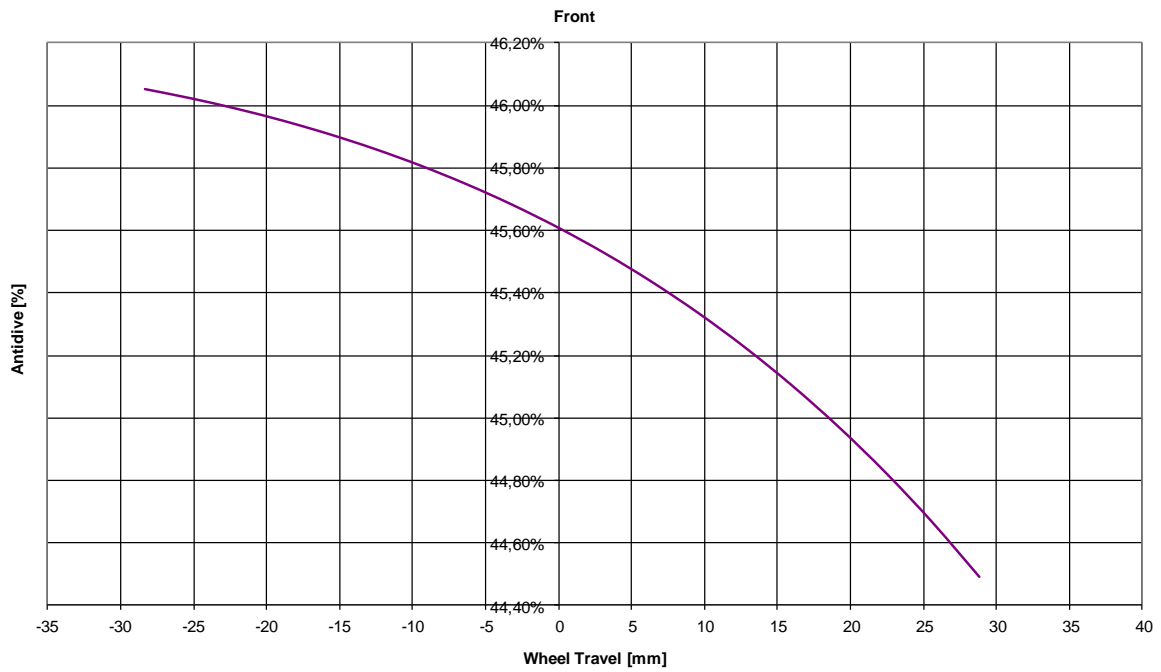

Antidive (dynamic) vs Wheel Travel

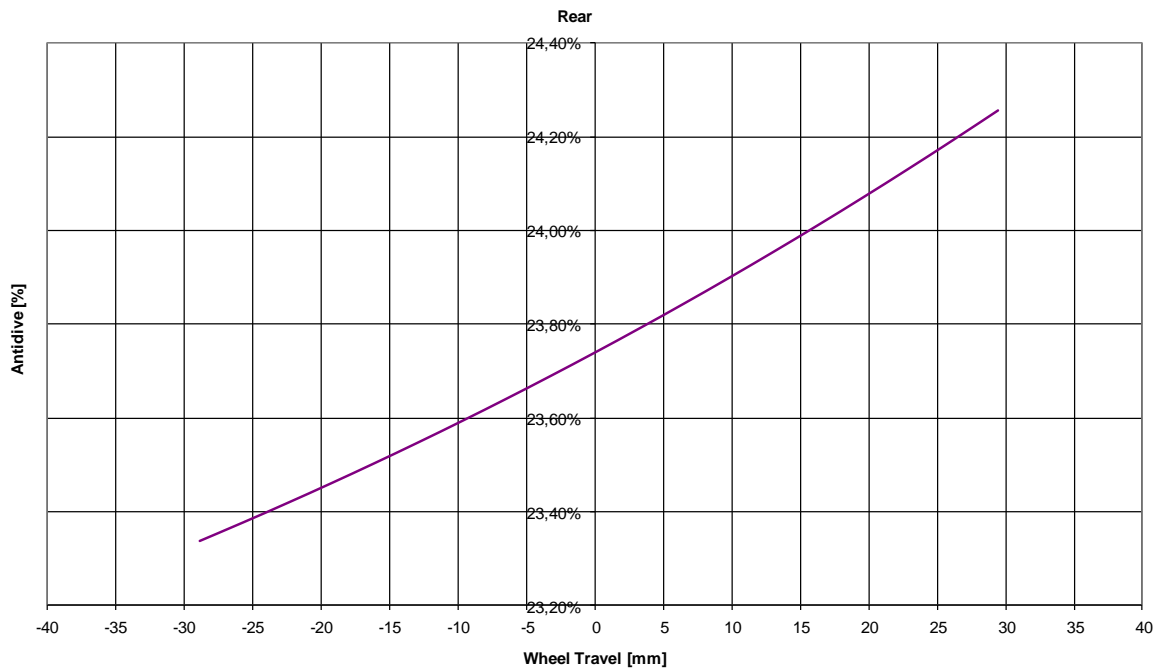

9.3.10. Antisquat vs Wheel Travel

Antisquat (kinematic) vs Wheel Travel

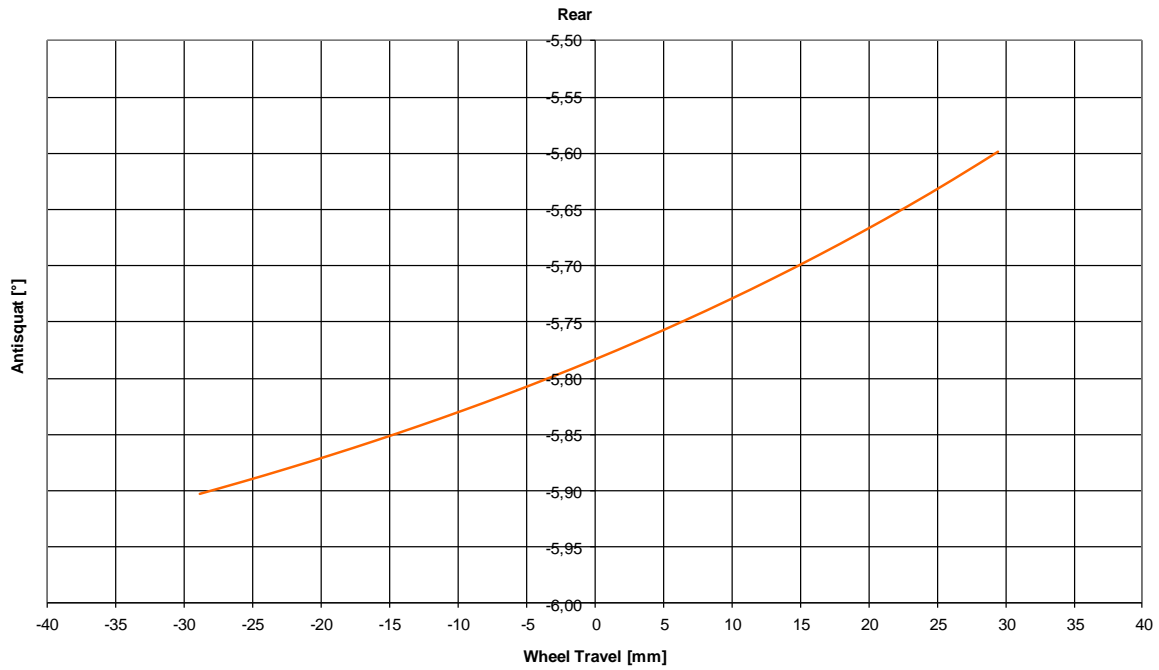

Antisquat (dynamic) vs Wheel Travel

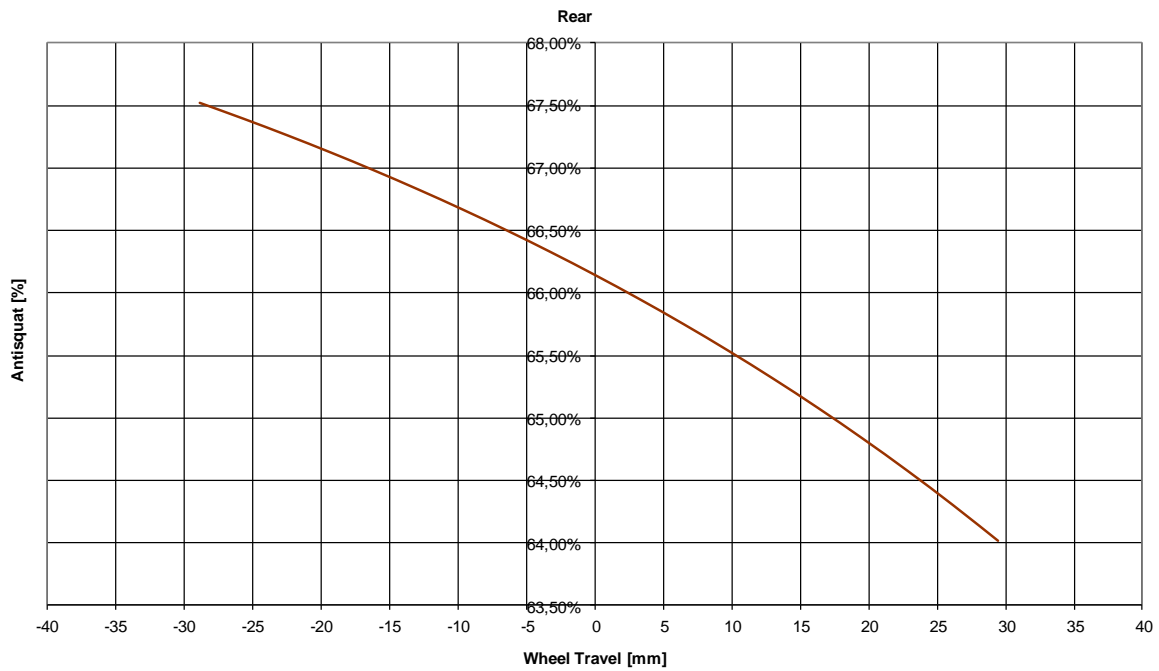

9.4. Springs

The car is equipped with the standard springs mentioned in the standard setup sheet (see 9.1 Standard Setup).
The available springs are described in the table below.

9.4.1. Front Suspension Springs

Spring nr.	Length	Length	Ø interna	Ø interna	Spring Rate	Spring Rate	Spring Travel	Spring Travel	Max Load	Max Load	Weight	Weight
	[mm]	["]	[mm]	[inch]	[N / mm]	[Lbs / inch]	[mm]	[inch]	[Newt on]	[Lbs]	[Kg]	[Lbs]
140 60 260	140	5.51	60.00	2.36	260	1484.00	56.896	2.24	14820	3330.00	1.39	3.06
120 60 320	120	4.75	60.00	2.36	320	1826.59	50.038	1.97	16000	3595.65	1.35	2.98
120 60 360	120	4.75	60.00	2.36	360	2054.92	48.006	1.89	17280	3883.31	1.54	3.40

9.4.2. Rear Suspension Springs

Spring nr.	Length	Length	Ø interna	Ø interna	Spring Rate	Spring Rate	Spring Travel	Spring Travel	Max Load	Max Load	Weight	Weight
	[mm]	["]	[mm]	[inch]	[N / mm]	[Lbs / inch]	[mm]	[inch]	[Newt on]	[Lbs]	[Kg]	[Lbs]
170 60 150	170	6.70	61.75	2.43	150	857.00	94.000	3.70	14093	3167.00	1.37	3.02
170 60 170	170	6.70	61.75	2.43	170	971.00	92.000	3.62	15704	3529.00	1.51	3.33
170 60 200	170	6.70	61.75	2.43	200	1042.00	84.000	3.31	16900	3790.00	1.72	3.79

9.5. Dampers

The car is equipped with non-adjustable dampers, as standard spec.
 Refer to 2016 GT4 Homologation sheet for optional adjustable shocks

Maserati GranTurismo MC - Trofeo - Front - MAS2

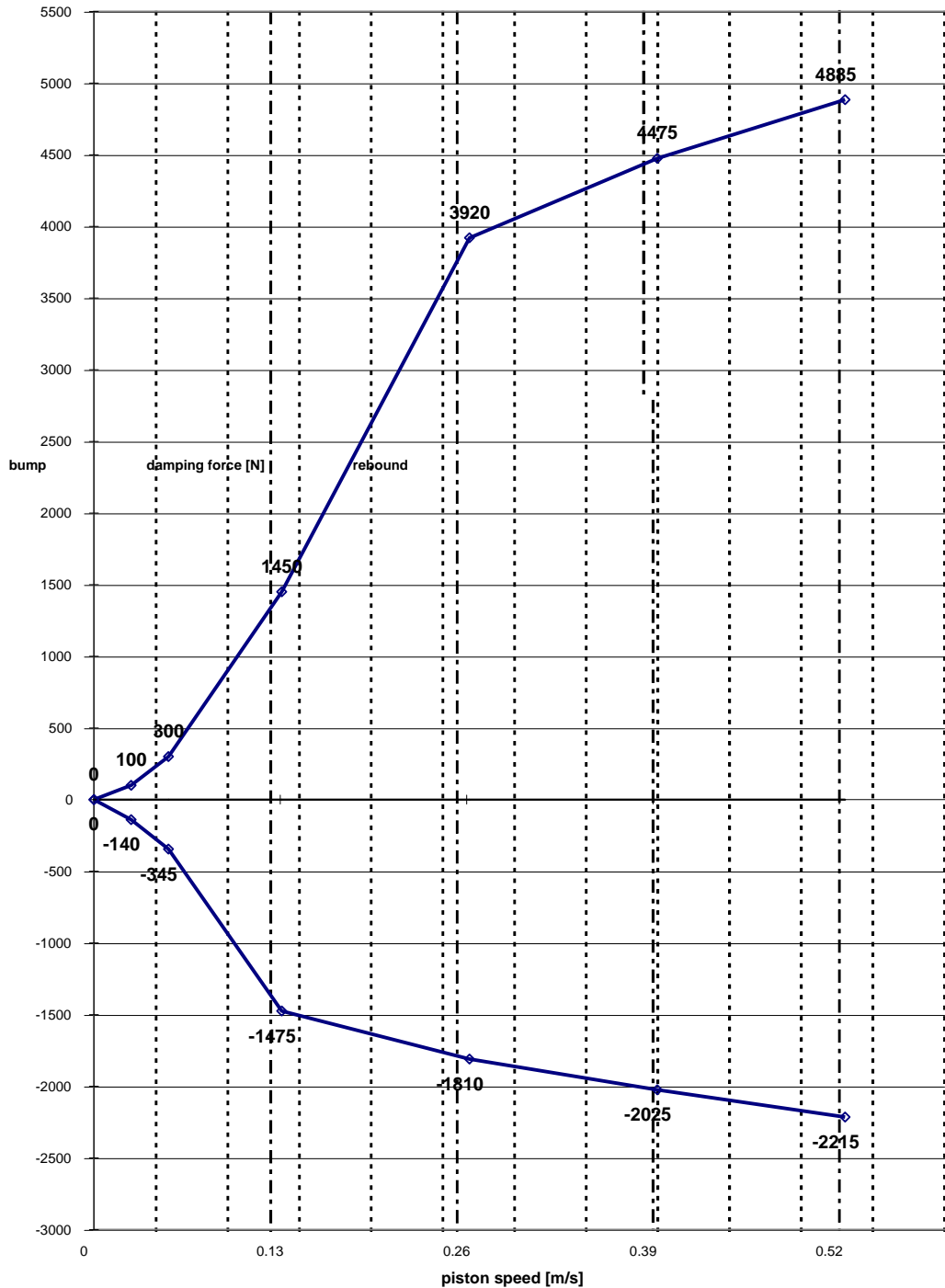

Maserati GranTurismo MC Trofeo - Rear - MAS3

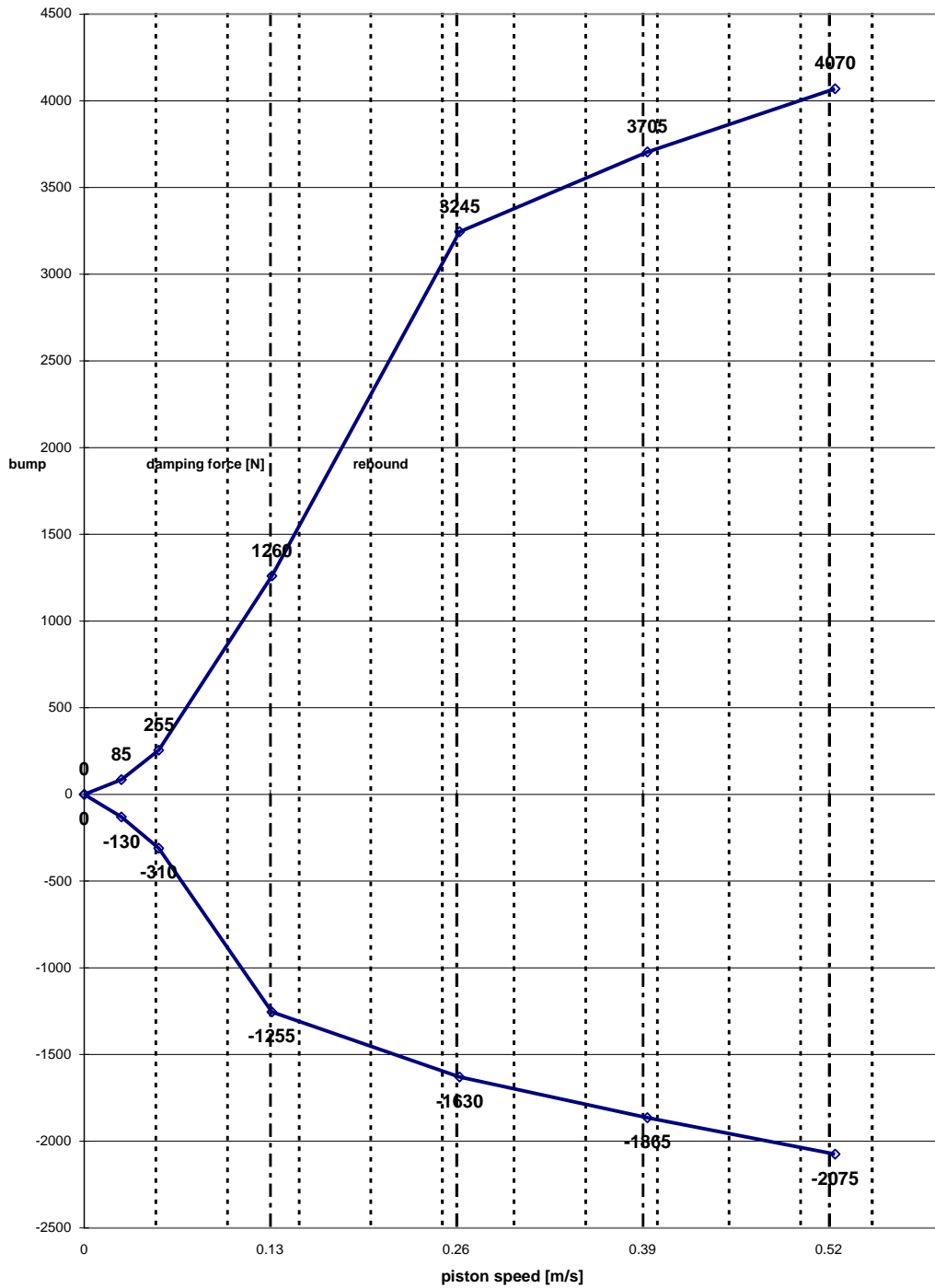

9.5.1. Bump Stop



00 1748 060 000

displacement [mm]	force [N]
0	0
5	135
10	255
15	390
20	810
25	4000

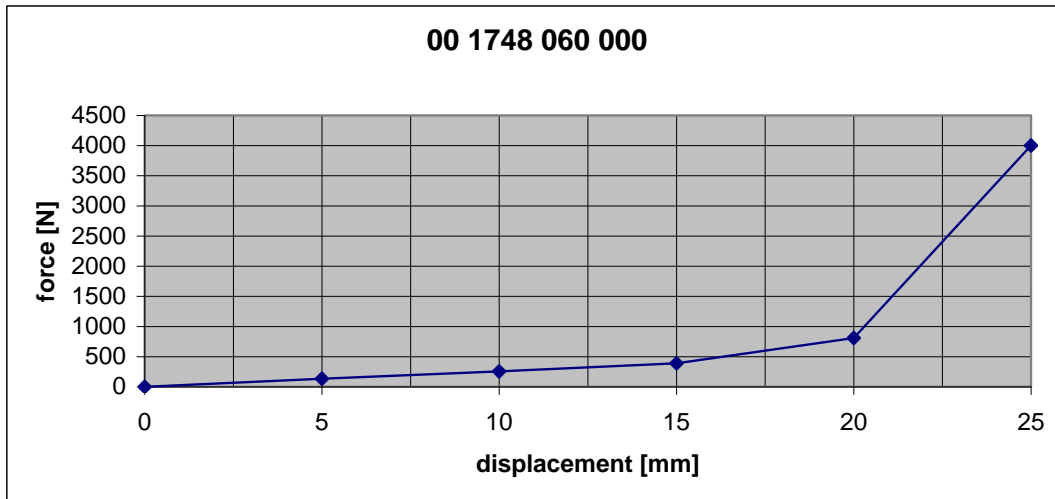
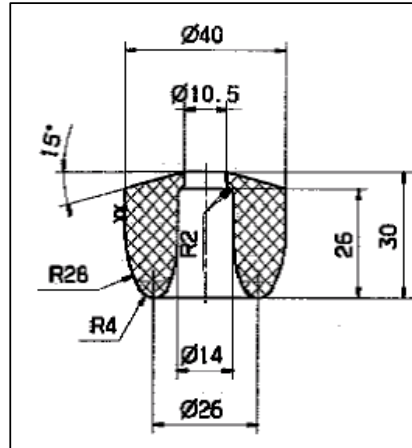

measurement of characteristic without consideration of hysteresis (average value)
 # bumper guided on piston rod (diameter 15 mm) during measurement (outer diameter of bumper not guided)

8.5.2. Packers

In addition to the bump stop, the car is running with the following packers:

-**Front** 15 mm totally (12+3), see the picture below.

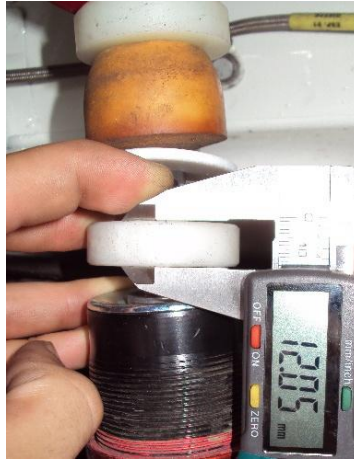

-**Rear** 10 mm, see the picture below.



It's recommended to have all packers installed, in order to avoid any contact of tyres with the wheel-arches on the chassis, in case of strong bumping.

9.6. Anti Roll Bar

9.6.1. Front Anti Roll Bar

Only one anti roll bar is available, Maserati P/N 239268.
It is a Ø26 outside diameter, Ø17.6 inside diameter hollow bar.

9.6.2. Rear Anti Roll Bar

The standard Trofeo spec rear antiroll bar is Ø25 x 1,5 mm.

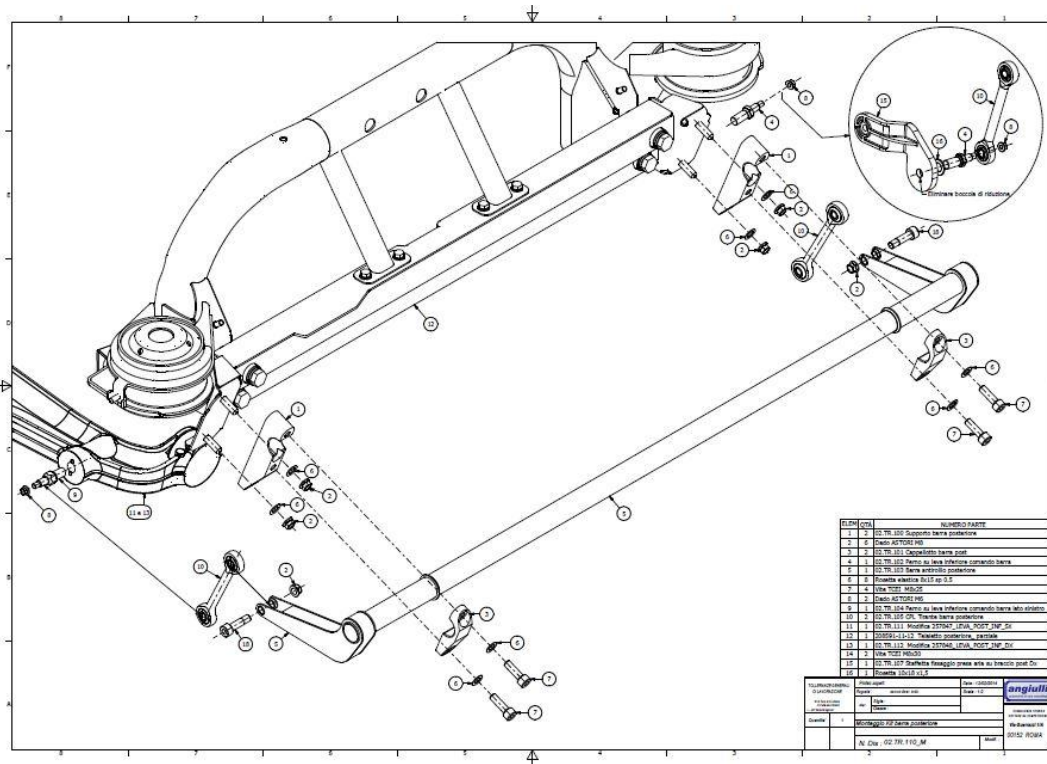

The 2016 GT4 Homologation allows the application of the adjustable rear anti roll bar, provided with the 2016 GT4 upgrade kit.



10. Steering system**10.1. Steering rack**

The car is equipped with a hydraulic power assisted steering rack. The power assistance is electronically controlled speed dependent. The control characteristic cannot be modified, but the electro-valve may be disconnected, obtaining a power assistance locked to its minimum value (heavier steering, better feedback from the road).

11. Suspensions

11.1. Tightening torques

Front suspension part	Part N.	Thread	Class	Tightening Torque Nm	Check Torque Nm	
					min	max
Lower Arm to Hub Carrier Adjustment Nut	247308	M14x1.5	A	63		
Lower Arm to Hub Carrier Fastening Nut	245240	M14x1.5	A	63	61	82
Upper Arm to Hub Carrier Adjustment Nut	247308	M14x1.5	A	63		
Upper Arm to Hub Carrier Fastening Nut	245240	M14x1.5	A	63	61	82
Damper to Lower Arm	Tab. 10312/03 1/62412/34 203666	M12x1.25	A	78	75	101
Lower Arm to Subframe (F)	240875 203795	M14x1.5	A	120	116	156
Lower Arm to Subframe (R)	240876 203795	M14x1.5	A	120	116	156
Upper Arm to Subframe	Tab. 10312 1/59779/34 203795	M14x1.5	A	120	116	156
Steering Link to Hub Carrier	102742	M10x1.25	A	40	39	52
Steering Link Lock Nut	Tab 10114 1/07913/24	M14x1.5	A	50	48	65
Top Mount to Chassis	ISO898/1 3099383	M8	A	25	24	32
Damper to Top Mount	Tab. 10356 261235 3096619	M12x1.25	A	98	95	127
Hub Bearing Assembly to Hub Carrier	203135	M10x1.25	A	60	50	75
Hub Bearing Preload Screw	249040 203780	M28x1.5	A	275	266	357
Brake Cooling Manifold to Hub Carrier	257960	M6	A	7.4	6.9	9.9
Calliper Adapter to Hub Carrier	249521	M14x1.5	A	120	116	156
Calliper to Adapter Stud	201261	M12	A	60	55	65
Calliper to Adapter Nut	201265	M12	A	60	55	65
Wheel Stud (Welded)	257868	M14x1.5	A	98	95	127
Wheel Nut	252544	M14x1.5	A	98	95	127

Rear suspension part	Part N.	Thread	Class	Tightening Torque Nm	Check Torque Nm	
					min	max
Lower Arm to Hub Carrier Adjustment Nut	247308	M14x1.5	A	63		
Lower Arm to Hub Carrier Fastening Nut	245240	M14x1.5	A	63	61	82
Upper Arm to Hub Carrier Adjustment Nut	247308	M14x1.5	A	63		
Upper Arm to Hub Carrier Fastening Nut	245240	M14x1.5	A	63	61	82
Damper to Hub Carrier	193058	M14x1.5	A	78	75	101
Toe Link to Hub Carrier	102742	M10x1.25	A	45	44	58
Lower Arm to Subframe (F) Stud with Cap Nut	204008 204010	M14x2 LH	A	35	34	45
Lower Arm to Subframe (F) Nut	203795	M14x1.5	A	120	116	156
Lower Arm to Subframe (R)	240874 203795	M14x1.5	A	120	116	156
Upper Arm to Subframe	Tab 10312 1/55413/34 102825	M12x1.25	A	98	95	127
Toe Link to Subframe	Tab 10357/03 1/63240/34 203657	M10x1.25	A	63	61	82
Toe Link Lock Nut (inner side)	Tab 10114 1/16911/24	M12x1 LH	A	78	74	82
Toe Link Lock Nut (outer side)	Tab 10112 1/07904/24	M14x1.5	A	50	48	65
Top Mount to Chassis	ISO898/1 3099383	M8	A	25	24	32
Damper to Top Mount	Tab. 10356 261235 3096619	M12x1.25	A	98	95	127
Driveshaft to Gearbox	181910	M10x1.25	A	80	77	104
Driveshaft to Hub	203780	M28x1.5	A	275	266	357
Hub Bearing Assembly to Hub Carrier	203135	M10x1.25	A	60	50	75
Brake Cooling Manifold to Hub Carrier	3099377	M6	B	7.4	6.9	9.7
Calliper to Hub Carrier Stud	249533	M10	A	50	45	55
Calliper to Hub Carrier Nut	249534	M10	A	50	45	55
Wheel Stud (Welded)	257868	M14x1.5	A	98	95	127

Wheel Nut	252544	M14x1.5	A	98	95	127
-----------	--------	---------	---	----	----	-----

11.2. Suspension Assembly

When checking and / or replacing suspension parts or when cleaning and lubricating the suspension joints, the disassembly of the suspension is needed. Following the procedure below to reassemble the parts correctly.

11.2.1. Front Suspension

The bushings of the suspension arms should be assembled as in the photos below

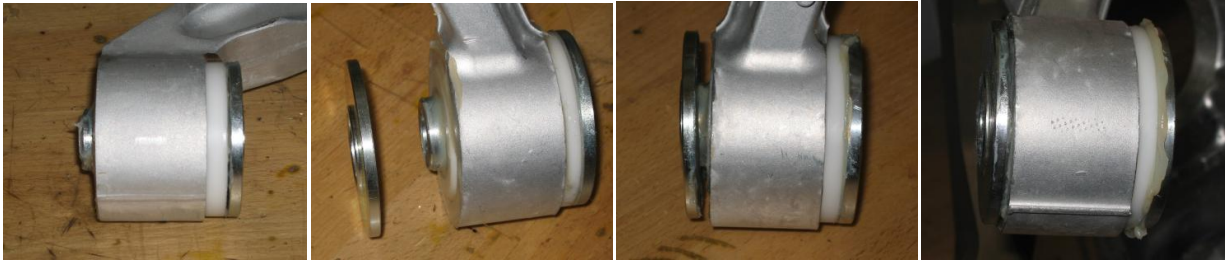

Remember to apply grease (driveshaft or ball bearing grease) between the bushing and the inner steel sleeve.

Fit the complete suspension assembly (hub carrier and arms) to the subframe, holding the arms in place by inserting the bolts. Pull the upper arm towards the front and locate the contact point (in the photos, the front joint of the upper arm). Apply spacers as needed to fill the clearance on the other side of the joint, as shown below.

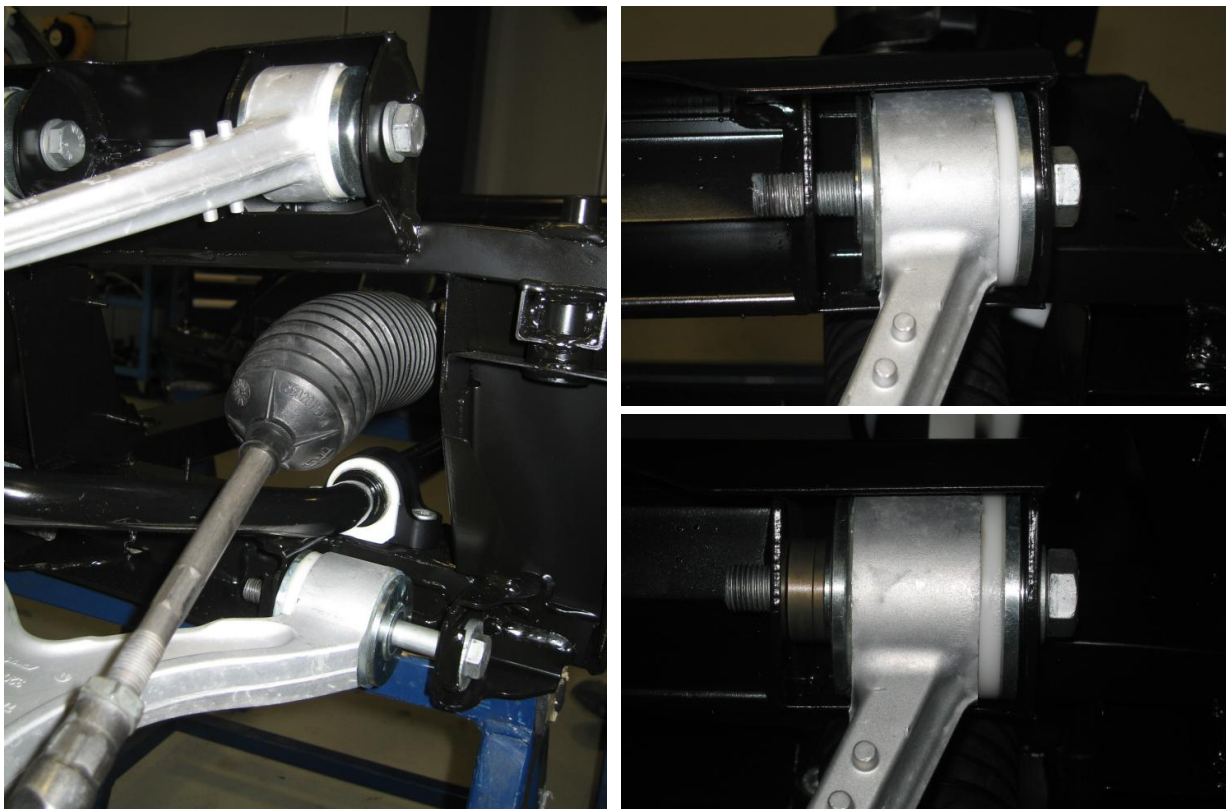

Insert spacers on the other joint on both sides, to fill the clearance, as shown in the photos below.

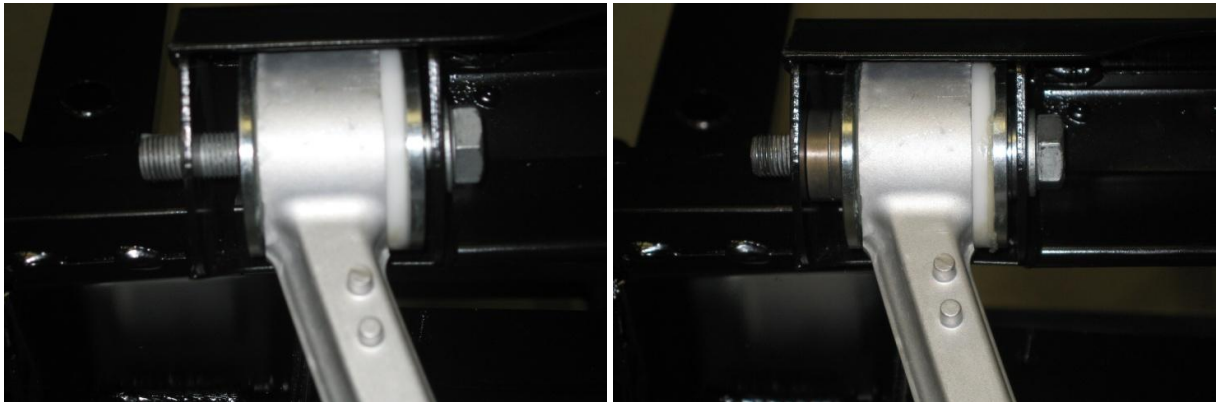

Assemble the nuts with medium strength (blue) thread locker. Tighten with the specified torque. Check that the suspension assembly moves freely, by hand.



Pull the lower arm towards the rear and locate the contact point. Under normal conditions it should be in the front joint. Apply spacers as needed to fill the clearance on the other side of the joint, as shown below.

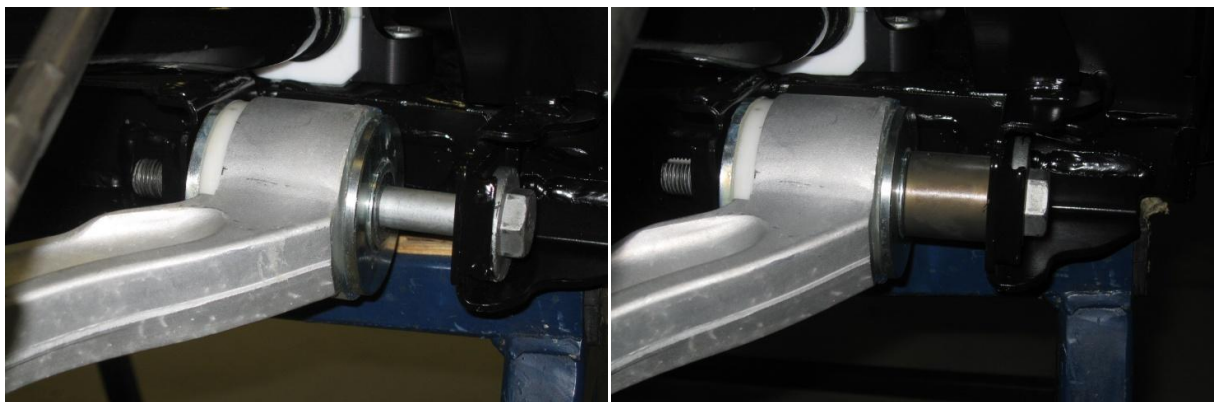

Insert spacers on the other joint on both sides, to fill the clearance, as shown in the photos below. Assemble the nuts with medium strength (blue) thread locker. Tighten with the specified torque. Check that the suspension assembly moves freely, by hand.

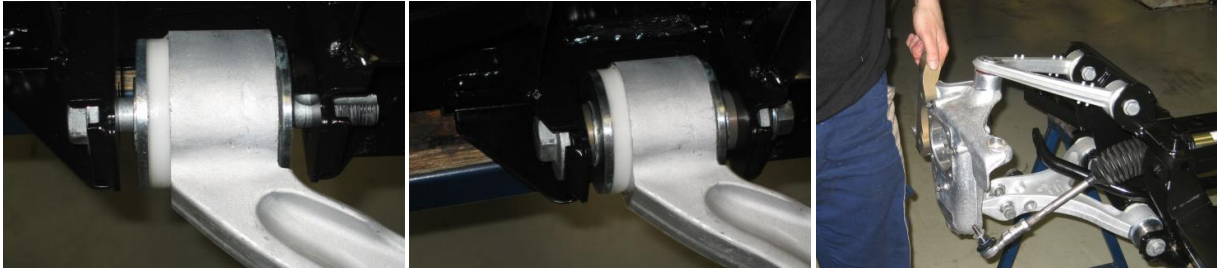

11.2.2. Rear Suspension

Refer to the photos of the front suspension for the assembly of bushings.

Remember to apply grease between the bushing and the inner steel sleeve.

Fit the complete suspension assembly (hub carrier, driveshaft and arms) to the subframe, holding the arms in place by inserting the bolts. Pull the upper arm towards the front and locate the contact point. Apply spacers as needed to fill the clearance on the other side of the joint.

Insert spacers on the other joint on both sides, to fill the clearance.

Assemble the nuts with medium strength (blue) thread locker. Tighten with the specified torque. Check that the suspension assembly moves freely, by hand.

Pull the lower arm towards the front and locate the contact point. Apply spacers as needed to fill the clearance on the other side of the joint.

Insert spacers on the other joint on both sides, to fill the clearance. Assemble the nuts with medium strength (blue) thread locker. Tighten with the specified torque. Check that the suspension assembly moves freely, by hand.

11.2.3. Suspension movement check

Check periodically the suspension movement. For this purpose, with the car on a lift or stands, and without wheels, disconnect the spring-damper assembly from the chassis, move the hub carrier by hand and check if it has a free movement. For the front suspension either disconnect the anti roll bar or disconnect both sides before checking. In case the movement of the suspension is not free enough, loosen one joint at a time and keep checking the movement. If the movement improves suddenly after the loosening of one joint, then the arm concerned has to be disassembled cleaned and lubricated, then reassembled following the procedures explained above. If the movement keeps improving after each loosening, then the entire suspension needs cleaning and lubricating.

11.3. Hub carrier assembly

Follow the procedure below to assemble the suspension arms to the hub carriers.

11.3.1. Front Hub Carrier

Put the upper arm in its seat on the hub carrier.

Fit the washer and screw on an adjustment nut to be used to fit the tapered coupling of the arm in the bushing on the hub carrier.



Fit a socket wrench in the hexagonal seat on the arm threaded pin.

Holding the threaded pin still, tighten the adjustment nut to a torque of 63 Nm.



Fully unscrew the adjustment nut and fit a new arm fastening nut on the threaded pin.

Tighten the retaining nut to a torque of 63 Nm.

Fit the lower arm in its seat on the hub carrier.

Fit the washer and screw on an adjustment nut to be used to fit the tapered coupling of the arm in the bushing on the hub carrier.

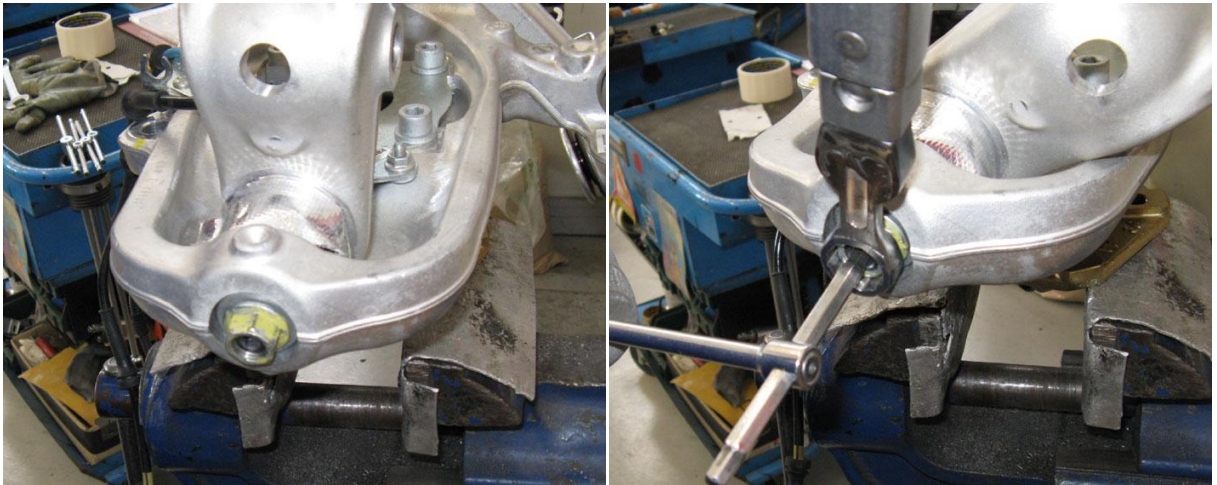

Fit a socket wrench in the hexagonal seat on the arm threaded pin.
Holding the threaded pin still, tighten the adjustment nut a to a torque of 63 Nm.
Fully unscrew the adjustment nut and fit a new arm fastening nut on the threaded pin.

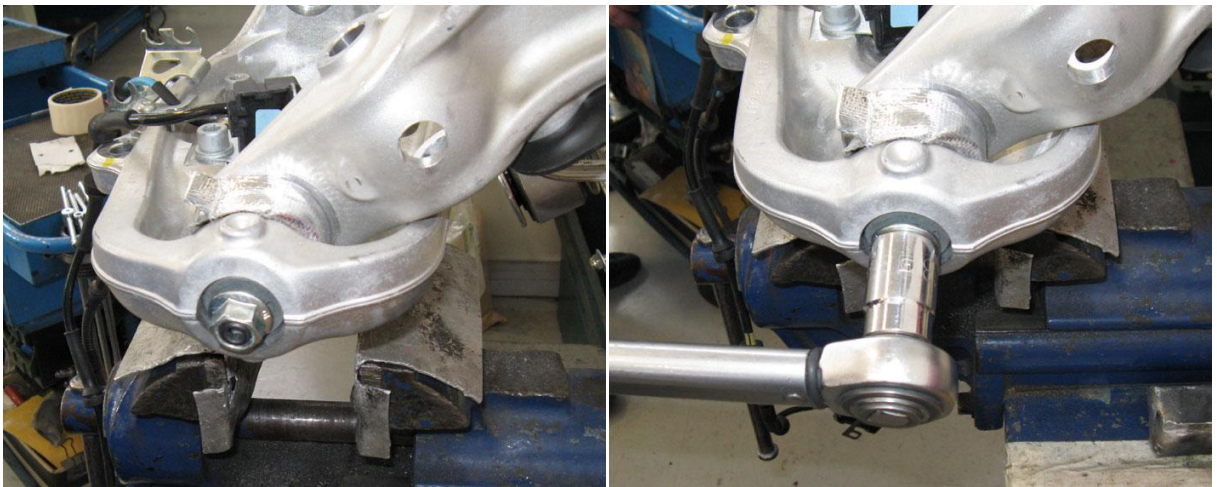

Tighten the retaining nut to a torque of 63 Nm.

11.3.2. Rear Hub Carrier

Install the rear tie rod on the rear hub carrier, following the scheme below

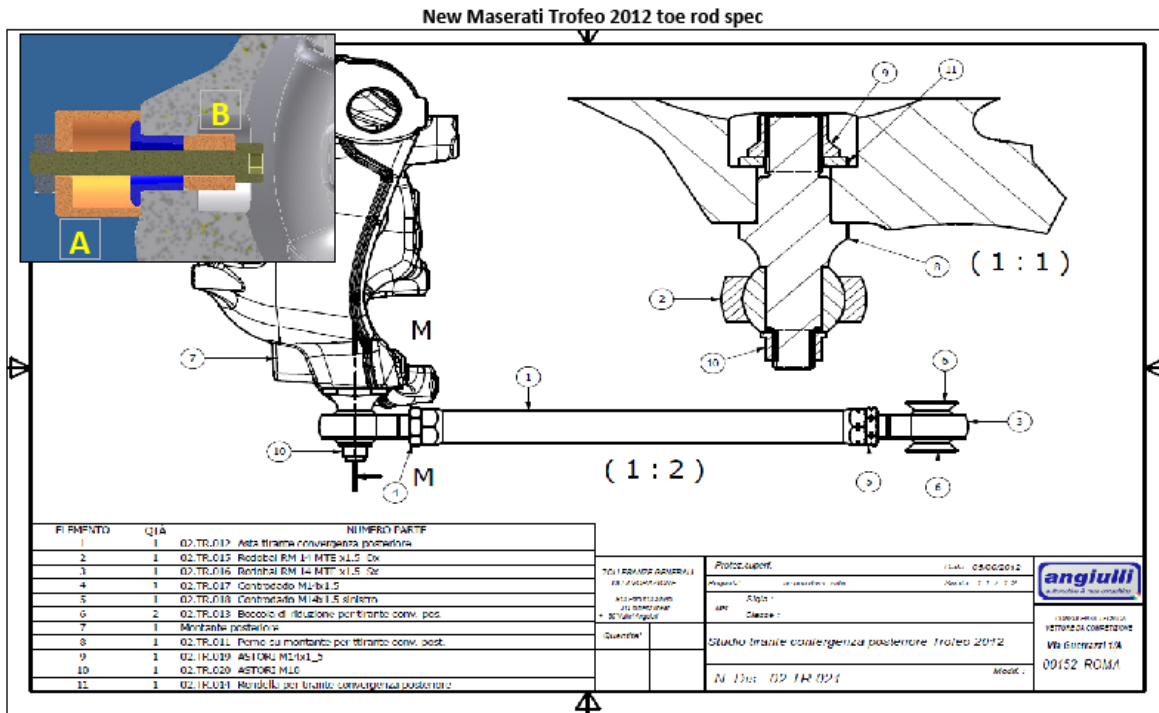

- 13 Removing the steel bushing (bleu color) using the extractor made in two parts (A+B). Heat the hub carrier until 80°C and insert the parts (8) taking care to keep the two flat side like in the picture.

Tightening torque

Nut M14x1,5 (9)	100	Nm
Nut M10x1,5 (10)	26	Nm



Fit the upper arm in its seat on the hub carrier.
 Fit the washer and screw on an adjustment nut to be used to fit the tapered coupling of the arm in the bushing on the hub carrier.

Fit a socket wrench in the hexagonal seat on the threaded pin of the arm.
Holding the threaded pin still, tighten the adjustment nut a to a torque of 63 Nm.

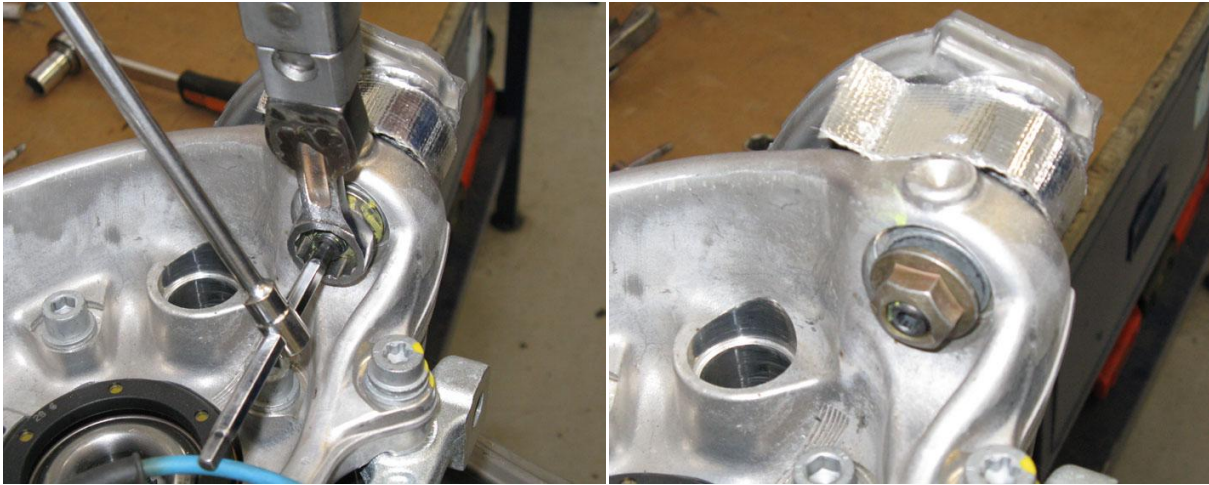

Fully unscrew the adjustment nut and fit a new arm fastening nut on the threaded pin.
Tighten the fastening nut to a torque of 63 Nm.

Fit the lower arm in its seat on the hub carrier.
Fit the washer and screw on an adjustment nut to be used to fit the tapered coupling of the arm in the bushing on the hub carrier.

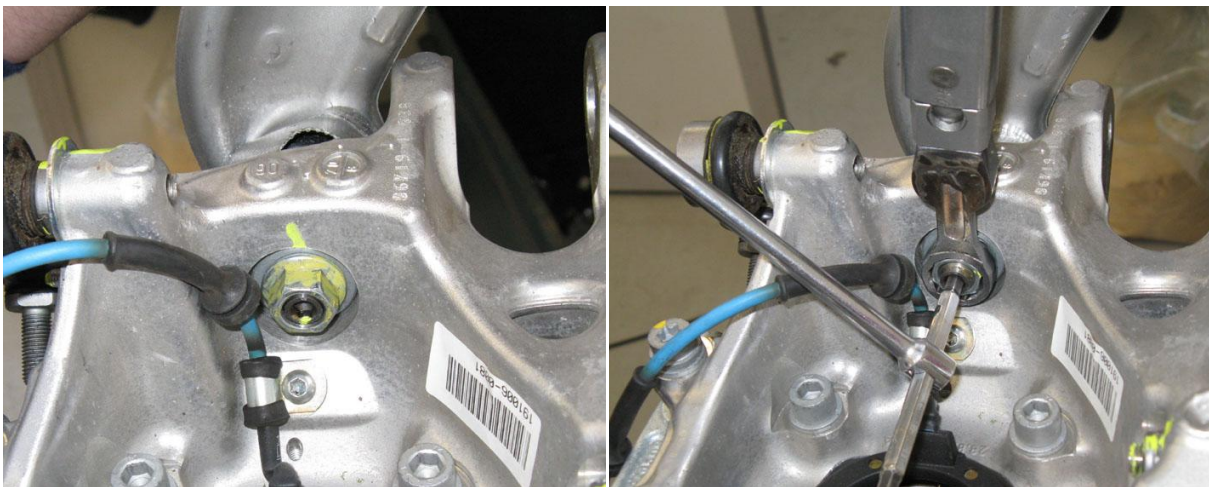

Fit a socket wrench in the hexagonal seat on the arm threaded pin.
Holding the threaded pin still, tighten the adjustment nut a to a torque of 63 Nm.

Fully unscrew the adjustment nut and fit a new arm fastening nut on the threaded pin

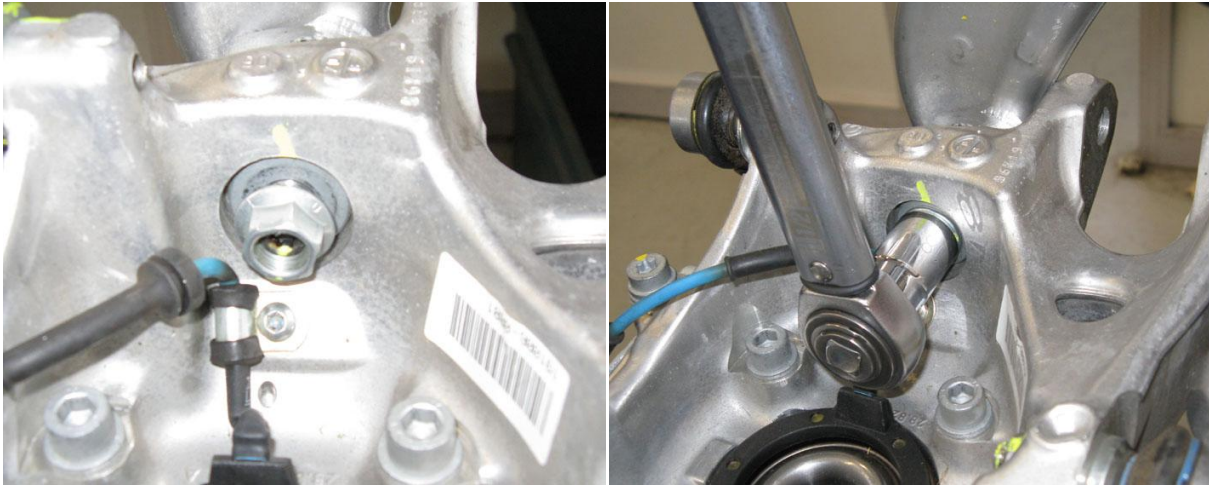

Tighten the fastening nut to a torque of 63 Nm.

11.3.3. Wheel spacers

The car is equipped with wheel spacers to increase the track, with the same thickness (25mm) but with a different tolerance of the central hole.

The front spacers are marked with "ANT", like in the pictures below (left and center). The rear spacers have no marking (right).

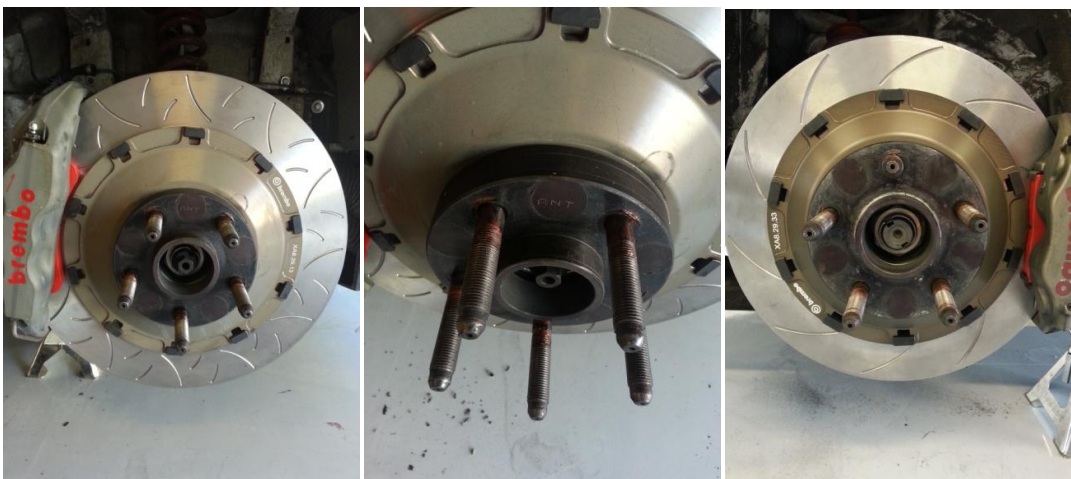

11.3.4. Lower front subframe engine support plate.

The mechanical stress caused by the continuous vibration of the engine may cause some cracking of the engine support housing on the lower front subframe.

To avoid the replacement of the entire subframe, install a specific plate on both sides, as shown below.

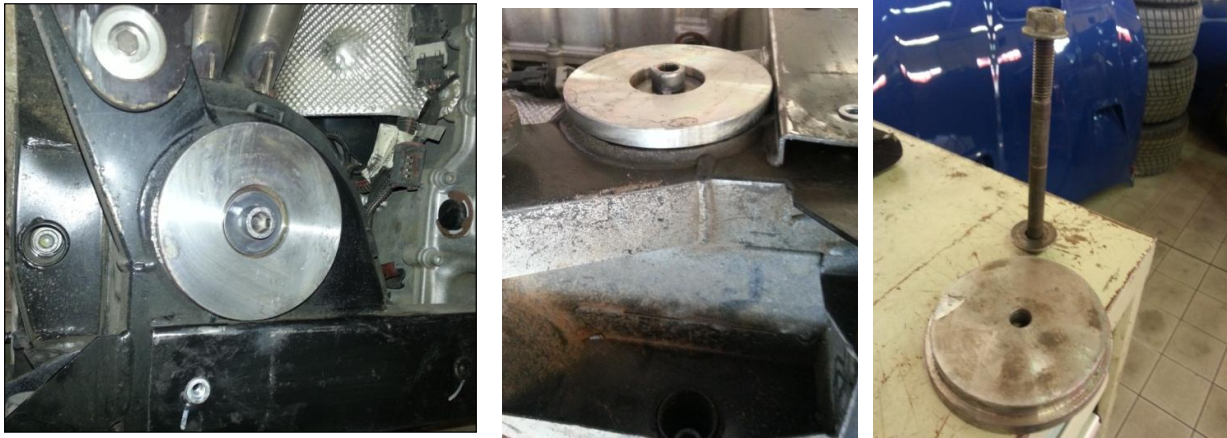

The installation of the metal plate requires the replacement of the original fixing screw with a new one M12x150 mm and a washer 35,8 x 2,5 mm.

The metal plate is not available as spare parts, but it can be produced by using the following drawing.

The metal plate is reported on the 2016 GT4 homologation form.

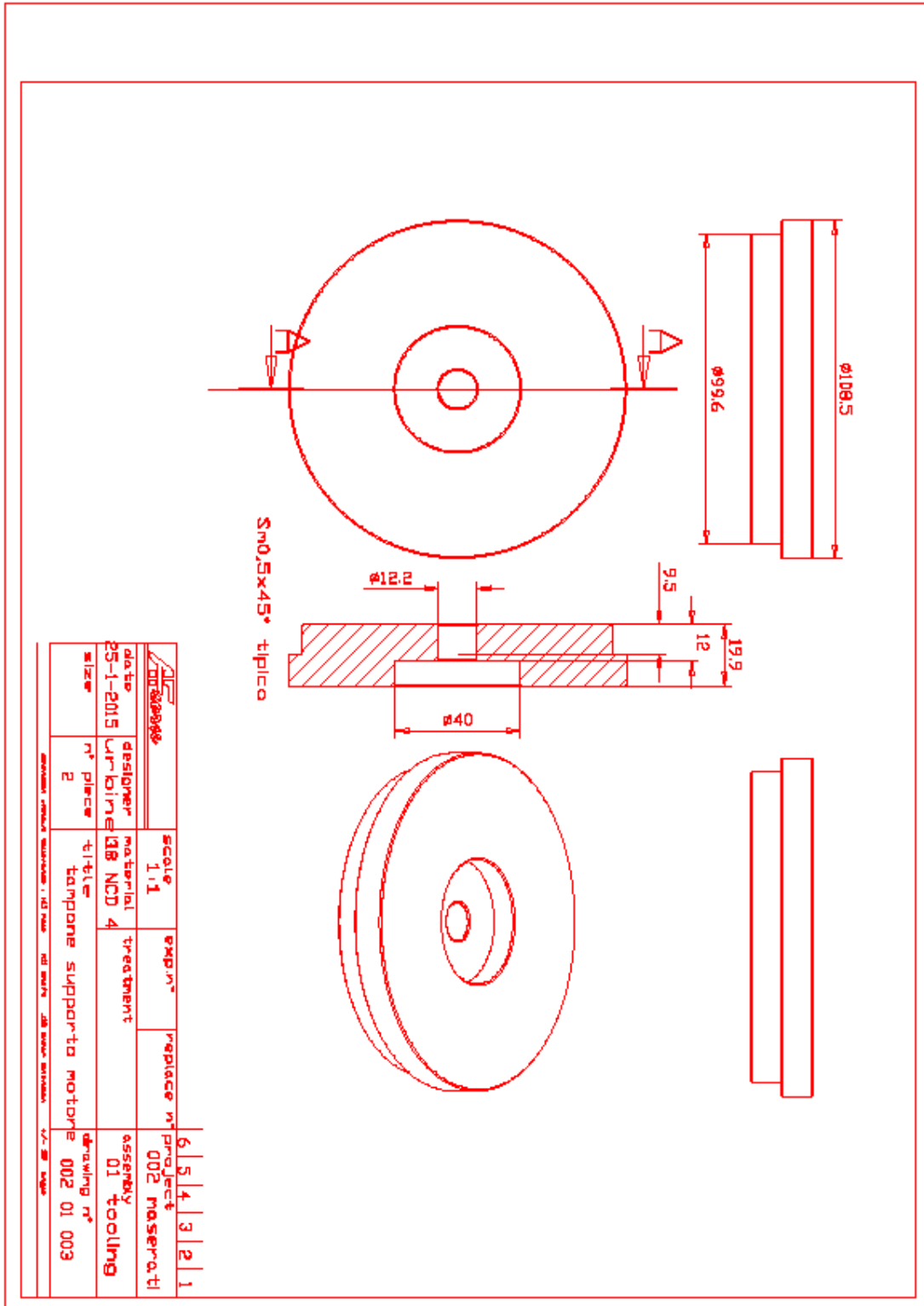

12. Wheels

12.1. Wheel Rims

Maserati P/N	Width	Diameter	Offset	Application
249962	11"	18"	39 mm	Front
252149	13"	18"	41 mm	Rear

12.2. Tyres

The following tyres have been successfully tested.

The tyres used in the Trofeo series are Pirelli.

Manufacturer	Size	Rim	Application	Rolling Circumference
Dunlop	285 / 650	11"	Front	1989 ¹
Dunlop	285 / 660	11"	Front	2023 ¹
Dunlop	315 / 690	13"	Rear	2140 ¹
Dunlop	310 / 710	13"	Rear	2203 ¹
Michelin	27 / 65	11"	Front	2009 ²
Michelin	31 / 71	13"	Rear	-
Pirelli	305 / 660	11"	Front	2087 ³
Pirelli	325 / 705	13"	Rear	2194 ³

Notes:

1. Estimated data
2. Measured data. Measurements between 300 and 800kg of vertical load and between 50 and 250 km/h have been interpolated to the actual vertical load (static) and 150 km/h speed.
3. Measured data. Measurements between 200 and 600 kg of vertical load and between 20 and 300 km/h have been interpolated to the actual vertical load (static) and 140 km/h speed.

11.2. Tyre pressure

For Pirelli tyres, it's strongly recommend to start in cold conditions with the following minimum pressures:

-Front tyres: 1,5 bar

-Rear tyres:1,4 bar

The target pressure in hot condition is between 1,9 – 2,0 bar.

13. Cockpit

13.1. Steering wheel commands

<i>Label</i>	<i>Function of the control switch</i>	<i>Label</i>	<i>Function of the control switch</i>
1	gear down shift paddle	4	gear up shift paddle
2	flash button	5	pit limiter button
3	reverse gear button	6	radio (PTT) button



13.2. Central console commands

Label	Function of the control switch	Label	Function of the control switch
1	starter button (press always firmly)	7	windscreen wiper
2	ignition switch	8	cockpit cooling fan (not working)
3	rain light switch	9	lights switch
4	direction indicator	10	windscreen heater (defroster)
5	main breaker switch	11	Brake cooling fan (not working)
6	fuel consumption reset button	12	fire extinguisher

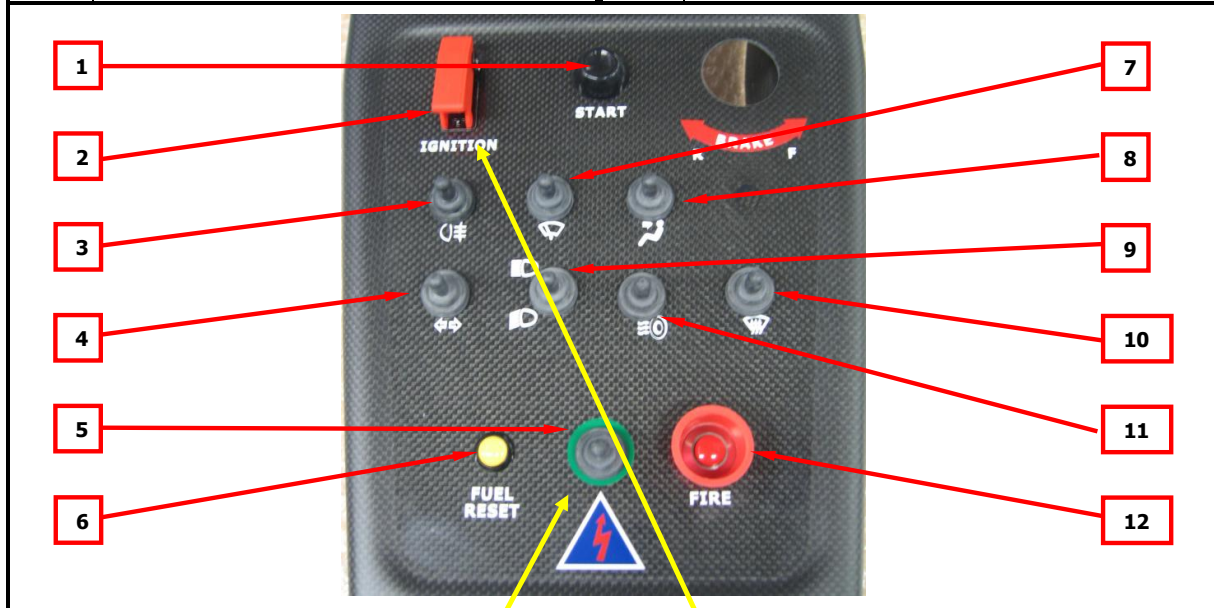

MAIN BATTERY SWITCH
 Operated by the Chief Mechanic or the Engineer

Switched on at the start of the session.

Switched off in case of EMERGENCY or when the car is parked in the pit.

IGNITION SWITCH
 (operated by the Driver)

13.3. Dashboard

The Car is equipped with a high brightness TFT dashboard. When turning on the "IGNITION" switch, the Maserati Logo remains few seconds on the screen, before changing to the standard screen shown below:

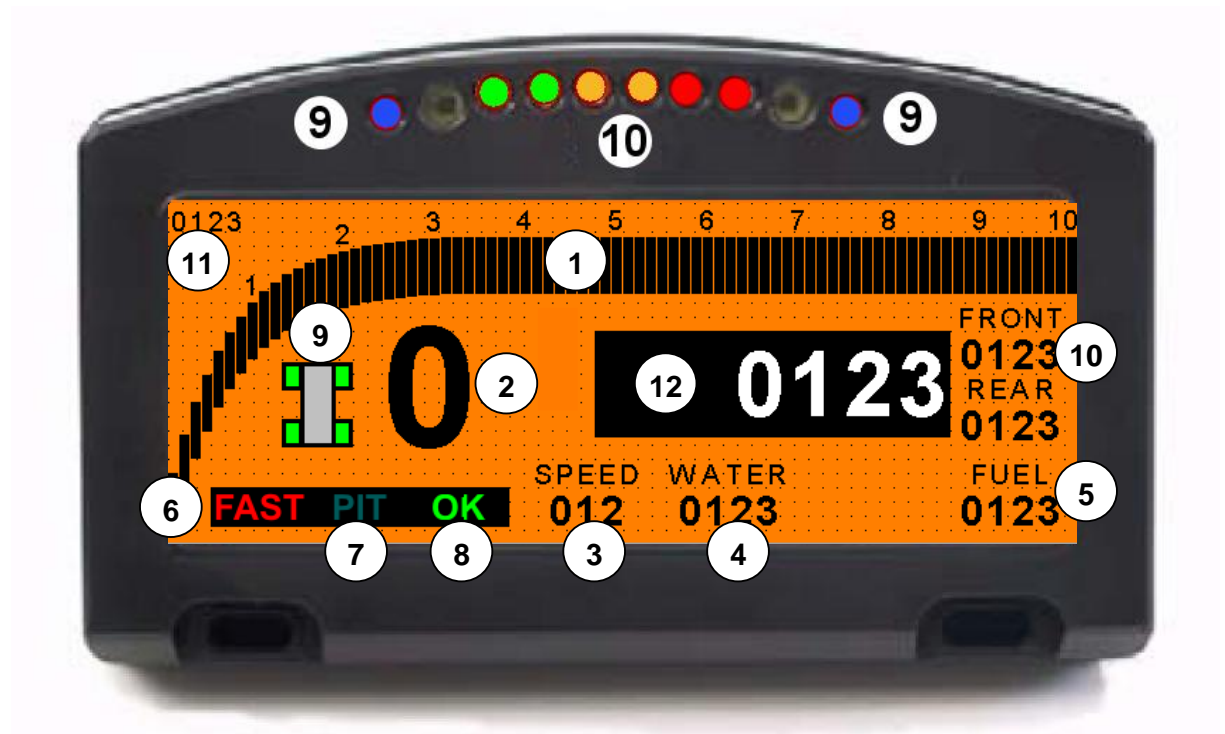

<i>Label</i>	<i>Item</i>	<i>Description</i>
1	RPM bar graph	Engine speed in graphic mode
2	GEAR	Gear engaged
3	SPEED	Car speed expressed in Km/h
4	TWATER	Engine coolant temperature expressed in °C
5	FUEL	Fuel consumption expressed in kg (density assumed 0.75 kg/l)
6	FAST	Fast Gearshift activation GREEN: Fast Gearshift Available RED: Fast Gearshift NOT Available
7	PITLIM	Pit Limiter activation: LIGHT BLUE: Pit Limiter Active DARK BLUE: Pit Limiter NOT Active Note: When the Pit Limiter is ON, the two blue leds blink (see n.9 on the upper led lights) NOTE: the pit limiter can be activated in any gear BUT it works ONLY in 2nd gear
8	PEDAL	Throttle pedal Warning to help for the optimal pedal during the Pit Limiter mode . PEDAL LOW (YELLOW): pedal must be increased PEDAL HIGH (RED): pedal must be decreased PEDAL OK (GREEN): pedal position is OK.
9	WHEEL LOCK	Wheel locking indicator. During braking, if one or more wheels lock the corresponding indicator changes to red. A line of red leds lights turn on as an additional warning
10	BRAKE P	Brake pressures, to check the correct brake balance.
11	ODOMETER	Car Odometer. Total car mileage in km.
12	LAPTIME	Lap time or split. Current lap time or difference vs the best lap time at specific time intervals.

To reset the best lap time, e.g. when moving to a different circuit, simply press the lower right button on the dashboard.



13.3.1. Alarm screen & warning lights

If the dashboard screen turns in one of the following mode, slow down the car immediately, drive it in the closest safe area and switch off the engine.

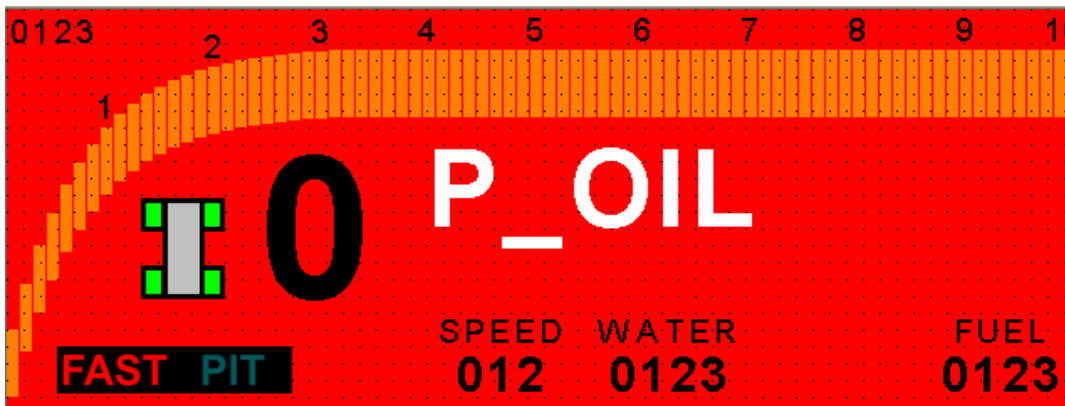
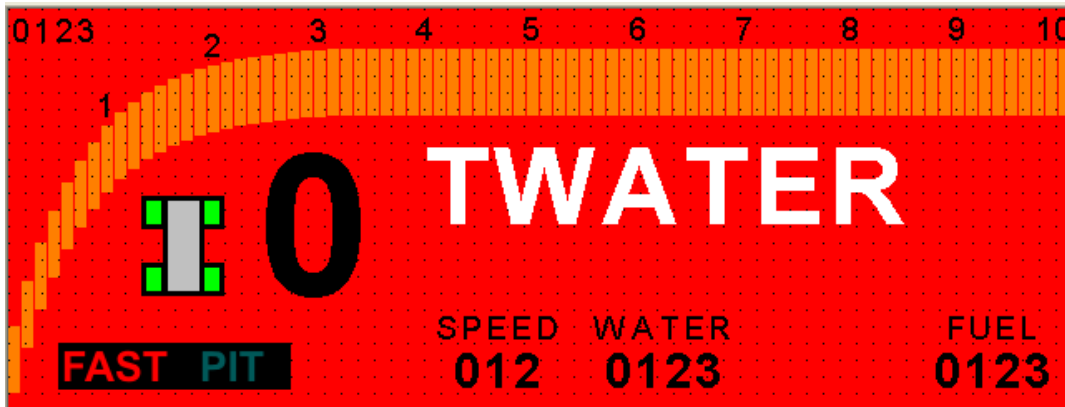

The small display positioned on the central console provides the following information



	Element	Description
1	WINDSCREEN HEATER light	Function: windscreen heater status indication Mode: ON when W/S heater is ON Note: the W/S cannot be activated if the engine is not running
2	GEARBOX FAILURE light	Function: gearbox failure warning Mode: ON if the gearbox is in failure mode
3	GENERATOR light	Function: alternator failure warning Mode: ON if the alternator is not working (failure or engine off)
4	LEFT BLINKER light	Function: left blinker status indication Mode: blinks when the left blinker is activated
5	RAIN LIGHT light	Function: rain light status indication Mode: ON when the rain light is activated
6	POSITION BEAM light	Function: main lights switch status indication Mode: ON when the main lights switch is set on the ON position
7	LOW BEAM light	Function: low beam status indication Mode: ON when the beam selector is set on position LOW or HIGH
8	HIGH BEAM light	Function: high beam status indication Mode: ON when the beam selector is set on position HIGH
9	RIGHT BLINKER light	Function: right blinker status indication Mode: blinks when the right blinker is activated

13.4. Rolling rest procedure

In case of **"Car's spin"** or in case of **"Gearbox malfunction"** during the track session, the Driver can apply the following procedure to reset the system (applicable also while moving):

- 1) Turn the IGNITION SWITCH to OFF (down), by using the red safety lock;
- 2) Turn the MAIN BATTERY SWITCH to OFF (down);
- 3) Wait 5 seconds;
- 4) Turn the MAIN BATTERY SWITCH to ON (up);
- 5) Wait 5 seconds;
- 6) Turn the IGNITION SWITCH to ON (up);
- 7) Engage the NEUTRAL gear (pulling both paddleshifts at once)
- 8) Press firmly the START button;
- 9) Check the following parameters:
 - a. WATER > 70° C
 - b. "FAST" lighted in GREEN
 - c. "BLUE LED" on the top right switched OFF

14. Fuel system

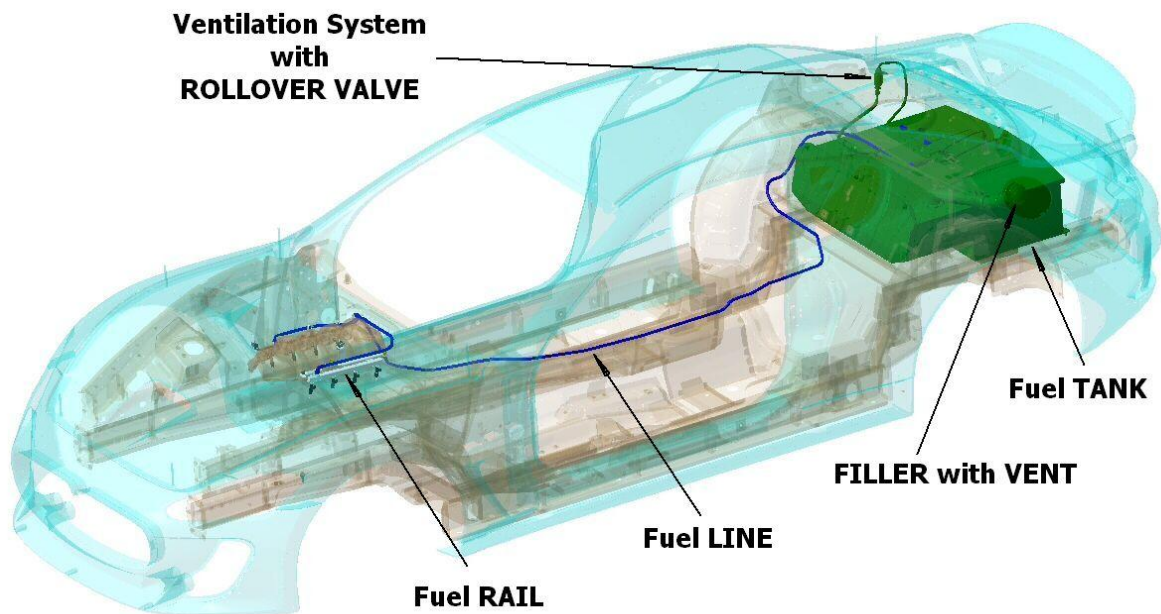

14.1. Fuel tank

The fuel tank is located in the luggage compartment.

It is a FIA Standard FT3 – 1999 Homologated (SFT 41076) rubber bladder, protected by a carbon-composite rigid, crushable structure.

The nominal capacity is 107 ± 3 liters. The actual capacity should be determined by appropriate measurement.

The fuel bladder has a 5 years validity from the date of manufacturing.

14.2. Fuel Pumps

There are 2 fuel pumps connected in parallel and supplying a single fuel line. The fuel pumps are located inside the fuel tank.

No fuel nourice and no transfer pumps are present.



When performing any maintenance operations on the fuel pumps, be extremely careful to avoid any damage to the o-ring located under the ring caps. It is recommended to replace it with a new one each time the ring cap is opened. Before installing, apply Hylomar sealant and lubricate the ring cap with silicon grease. Tighten the ring cap to 65 Nm.

14.3. Fuel level

The car is not equipped with a fuel gauge.

The measurement of the fuel consumption is based on the ECU fuel injectors' timing calculation, displayed on the dashboard and available in the data acquisition system.

The fuel level can be measured by monitoring the fuel fill and the fuel consumption data.

14.4. Refuelling

Use the standard fuel filler hose for the refuelling.

The quick refuelling system is available as optional part (see 13.6.)

Before starting to refuel, make sure that the fuel tank is empty (see 13.5.)

Measure accurately the fuel quantity before refuelling, possibly by weighing it. Use a scale with adequate precision (50 g max).

Reset the fuel consumption meter by pressing the console button for > 2 s.

14.5. Emptying

At the end of a session it is always recommended to pump out all the fuel from the car and weigh it, to cross check the fuel consumption measured from the car system. Emptying is needed also before filling, to be sure of the fuel level in the car.

The pump out of the fuel is possible by disconnecting the quick connector from the tank to the fuel line and connecting it to the specific hose 268496 (routed to an external canister), and by activating the fuel pumps with the specific harness 264468, and an external battery. Both parts are provided with the maintenance kit.

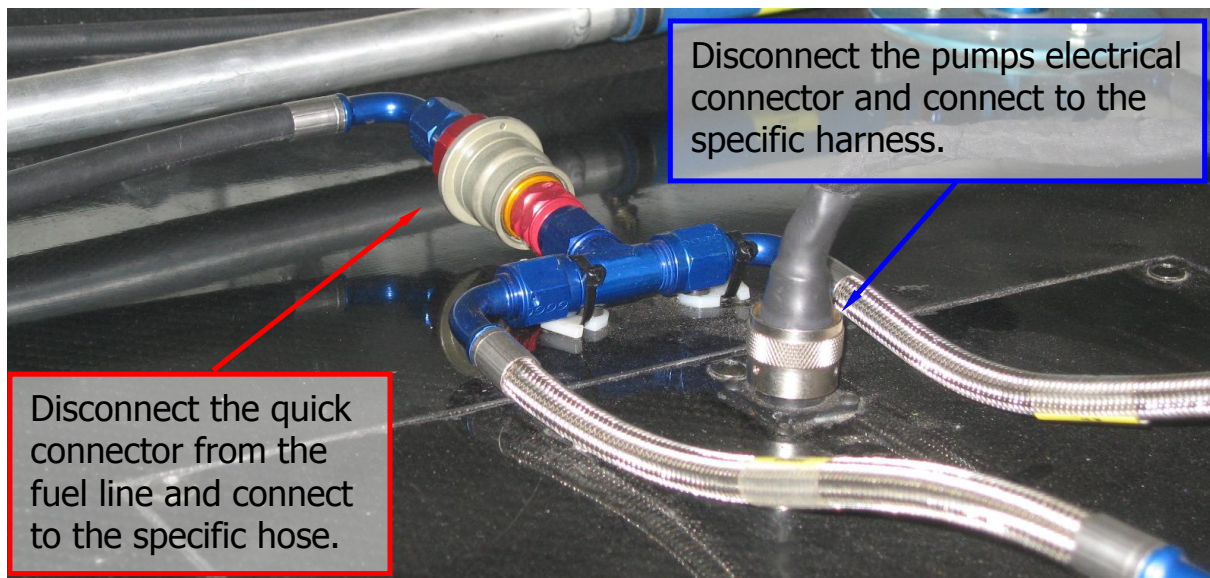

Always place the car on a flat surface before emptying the tank, or at least use always the same location.

Weigh accurately the fuel taken out. Be sure to empty the hose in the same canister before weighing.

NOTE

Before the start of a track event, the safety foam inside the tank might be dry.

It's always recommended to follow the procedure below:

The evening before the first track session fill the tank with 50 kg of fuel and leave it through the night.

Before the first track session, pump out all the fuel, and fill with the fuel quantity needed for the session.

At the end of the last session of the day pump out all the fuel and weigh it accurately.

Put 50 kg of fuel in the car and leave it through the night.

From the 2nd day on there is no need to pump out the fuel before running, unless a lower level of fuel is requested.

14.6. Quick Refuelling optional system

A quick refuelling system is available as optional part, suitable for endurance racing. The system is applicable on the standard equipment.

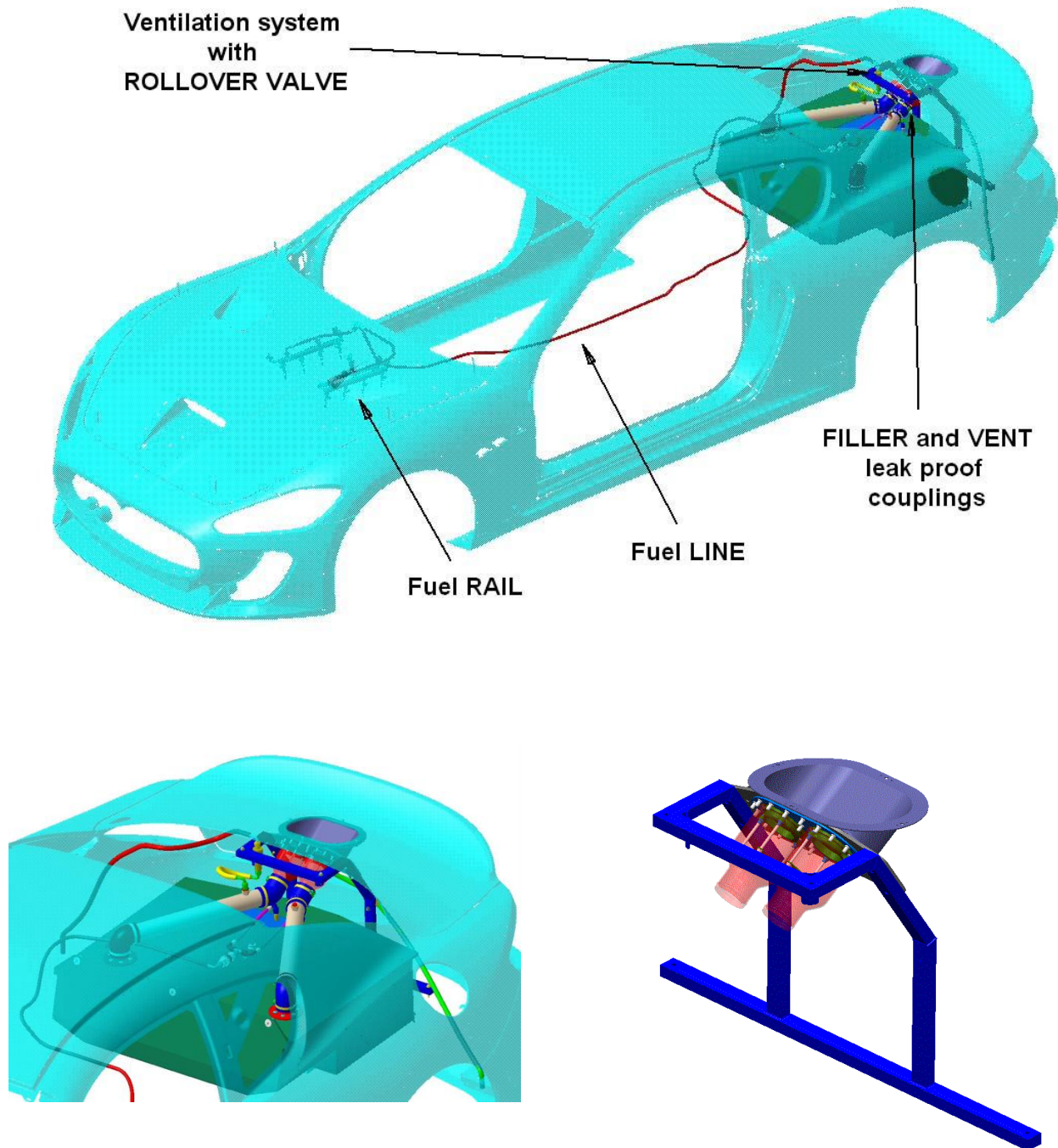

15. Electric & Electronic systems

For a more detailed overview of the wiring diagrams and the electric layout of the car, as well as the use of the diagnosis tool and relevant procedures / software, refer to the specific manual provided by Waycon and released by Maserati.

The following information are just a quick introduction and it's recommended to reconfirm the information with those reported in the dedicated manual.

15.1. Fuse & Relay boxes

The following scheme shows the layout of the Fuses and Relays

Data Acq., Power steering, Console, Multifunc. ECU <i>Maxi Fuse 40 A</i>	Fuel Pump R <i>Fuse 30 A</i>	Gearbox ECU Power <i>Fuse 10 A</i>	Radiator Fan L <i>Fuse 30 A</i>	Fuel Pump L <i>Fuse 30 A</i>	Lo Beam Head Lights <i>Relay 30 A</i>	Fuel Pump R <i>Relay 30 A</i>	Engine Main <i>Relay 30 A</i>	Radiator Fan L <i>Relay 30 A</i>
Lights <i>Maxi Fuse 40 A</i>	Hi Beam Head Lights <i>Fuse 10 A</i>	Wiper <i>Fuse 30 A</i>	Radiator Fan R <i>Fuse 30 A</i>					
Gearbox F1 pump <i>Maxi Fuse 50 A</i>	Lo Beam Head Lights <i>Fuse 20 A</i>		Injectors & Coils <i>Fuse 30 A</i>		Position Lights <i>Relay 30 A</i>	Main Fuel Pumps <i>Relay 30 A</i>	Cockpit Fan <i>Relay 30 A</i>	Radiator Fan R <i>Relay 30 A</i>
	Position Lights <i>Fuse 10 A</i>		Engine Main <i>Fuse 30 A</i>					
Engine Main, Fuel Pumps <i>Maxi Fuse 40 A</i>	Engine ECU Memory <i>Fuse 10 A</i>		Cockpit Fan <i>Fuse 30 A</i>					
Windscreen Defroster <i>Maxi Fuse 60 A</i>	Gearbox F1 Pump <i>Maxi Relay 50 A</i>		Starter <i>Maxi Relay 50 A</i>		Wind-Screen Defroster <i>Relay 30 A</i>	Hi Beam Head Lights <i>Relay 30 A</i>	Fuel Pump L <i>Relay 30 A</i>	Injectors & Coils <i>Relay 30 A</i>
Fans <i>Maxi Fuse 50 A</i>								

15.2. Main Breaker Relay

The main breaker relay (Kissling), located in the cockpit, disconnects the battery from all the electrical power devices, but it does not disconnect the alternator (and the starter motor supply) from the battery. In this way the main breaker switch and the emergency breaker switch will be able to kill the engine if still running. See scheme below.

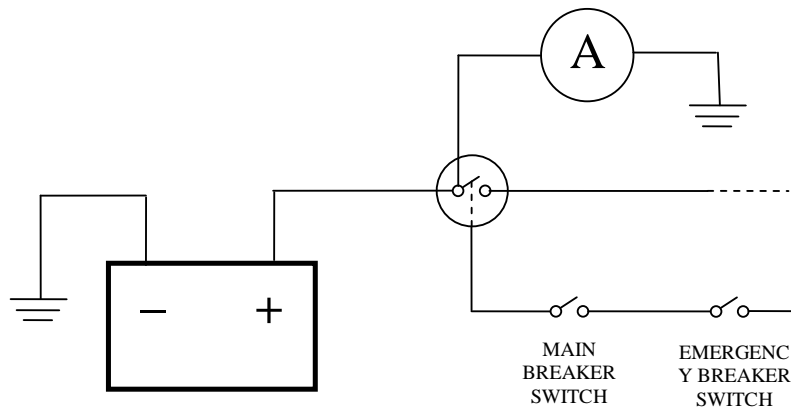

The connection shown below must be avoided, because it would not allow the main breaker switch and the emergency breaker switch to kill the engine if it still running. Indeed the alternator would keep providing electrical power to all the systems, including the engine.

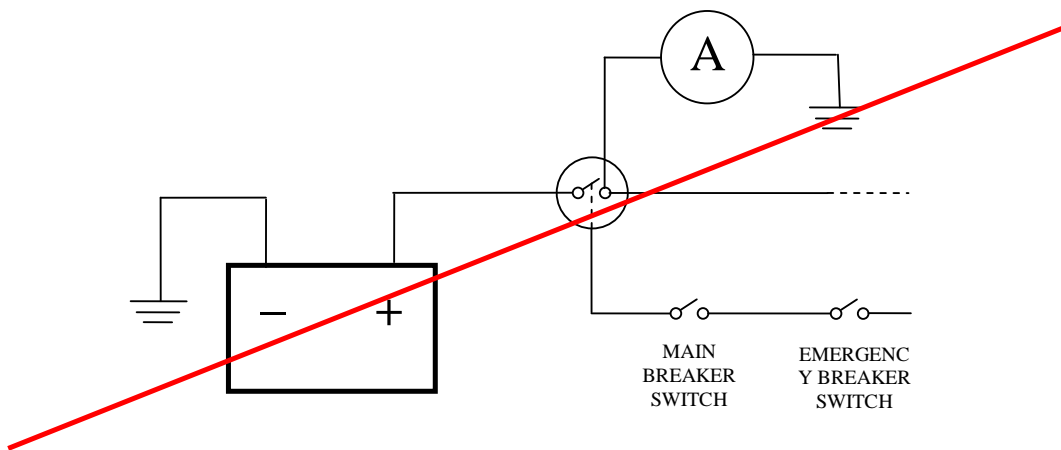

The main breaker relay includes a diode. If connected in reverse polarity the diode will blow. The right connection is shown in the photos below.

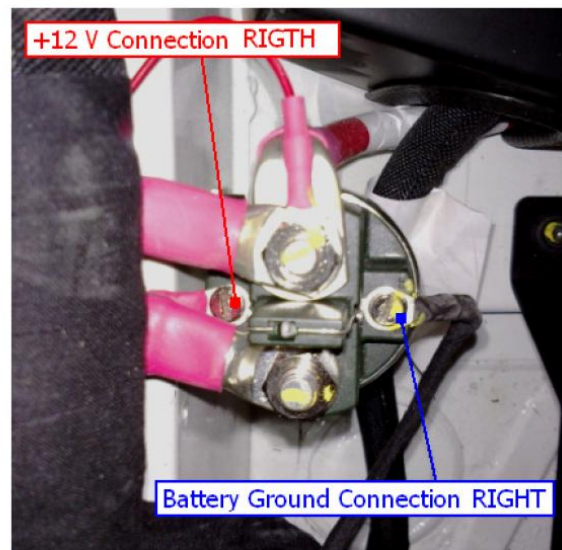

◆ ← Car driving direction → ◆

15.3. Sensors kit installation and configuration

The upgrade kit of sensors installed since the MY11 is made of:

- Nr. 1 CAN Steering Angle Sensor [p/n: 188171]
- Nr. 1 CAN Accelerometer + Gyro [p/n: 206070]
- Nr. 2 Analogic Pressure Sensors [p/n: 272832]
- Nr. 1 wire for CAN sensors [p/n: 277492]
- Nr. 1 wire for Analogic sensors [p/n: 277493]
- Nr. 1 Voltage regulator for Analogic sensors [p/n: 280855]
- Nr. 1 Idrostop (new Brake Light Switch) [p/n: 210376]

The location of the sensors and wirings is shown in the following pictures.

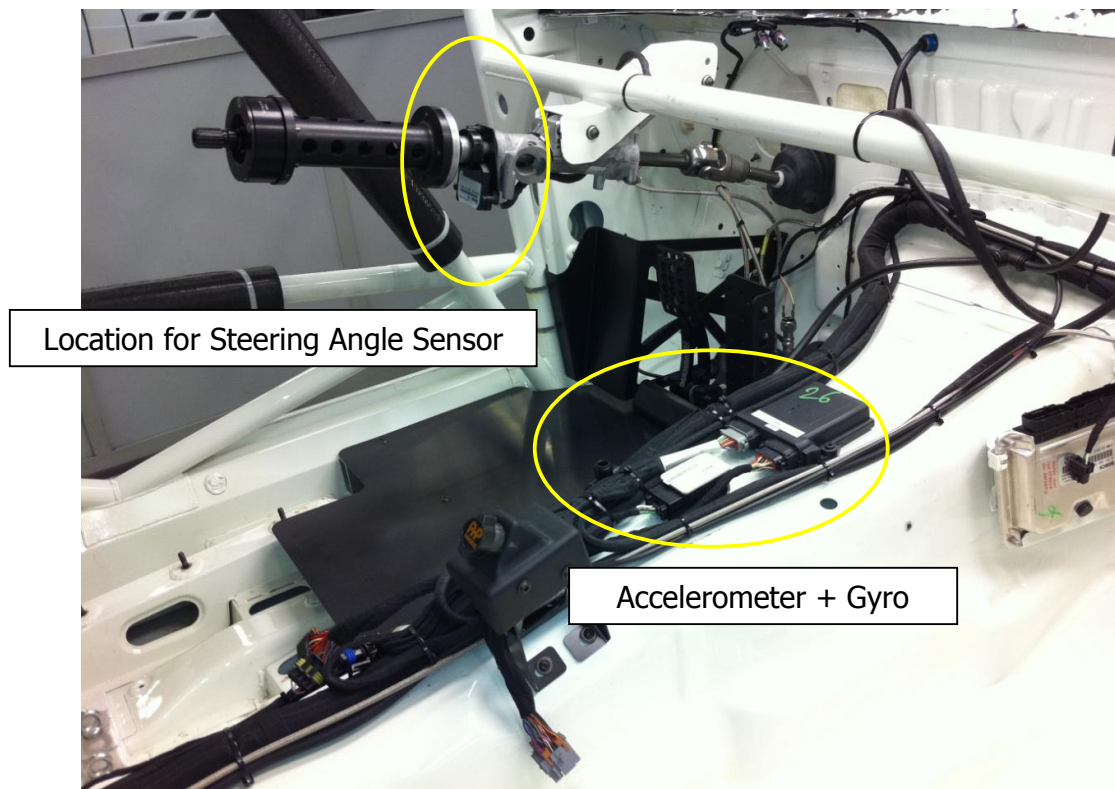

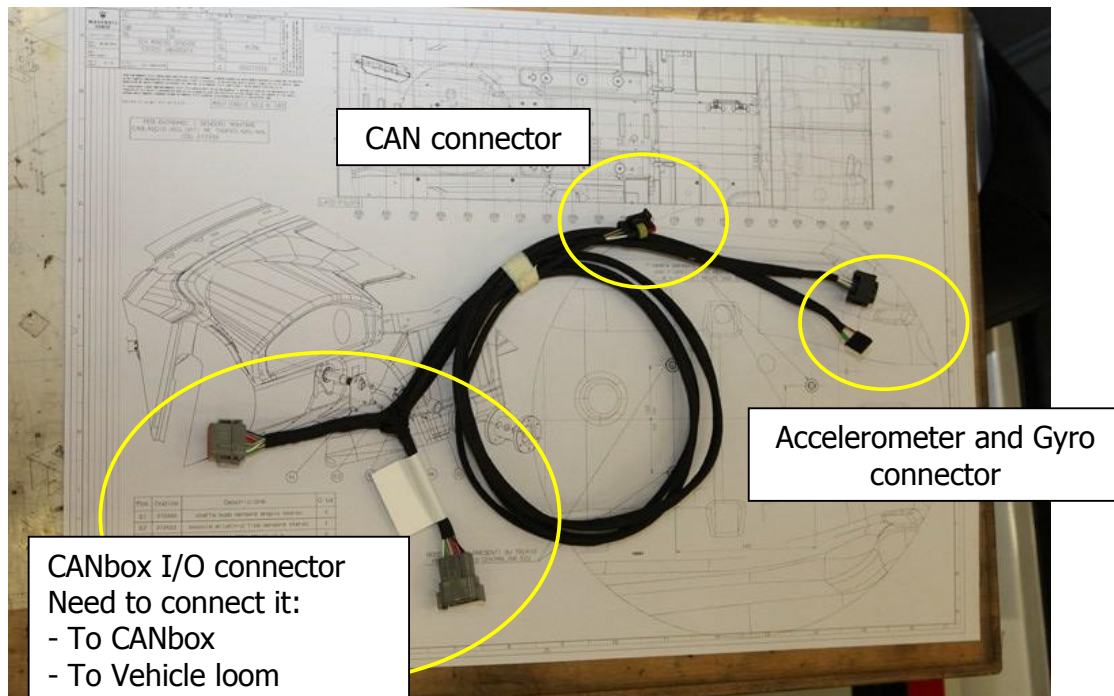
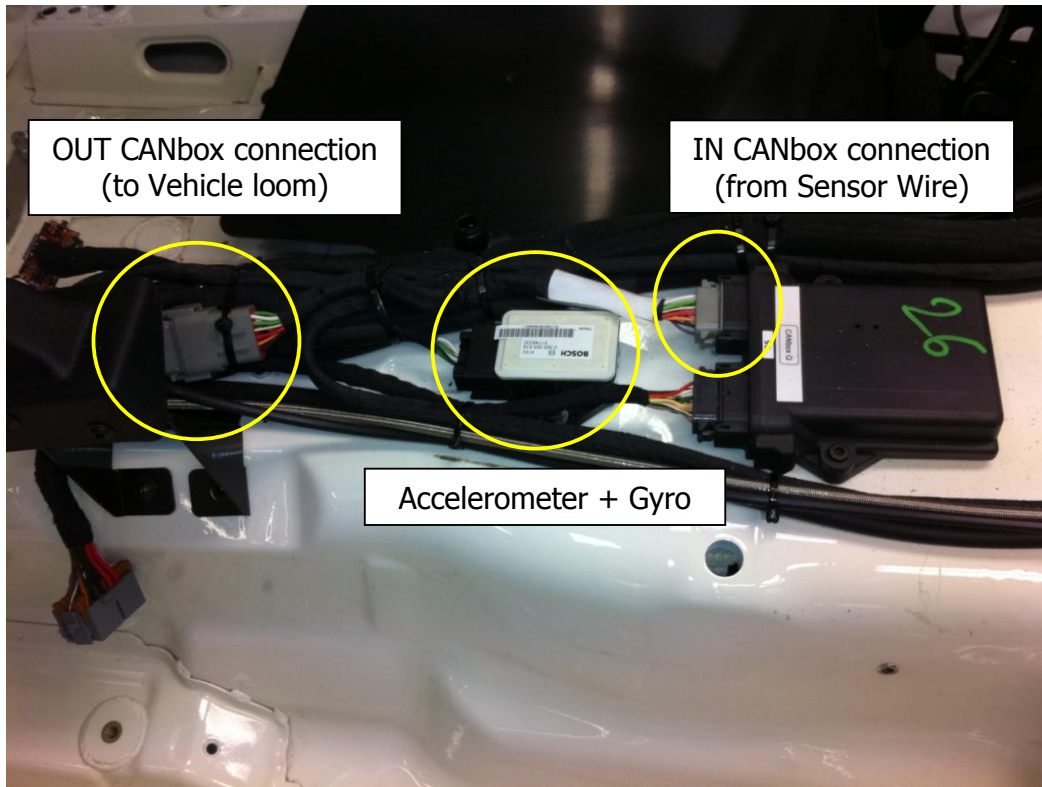

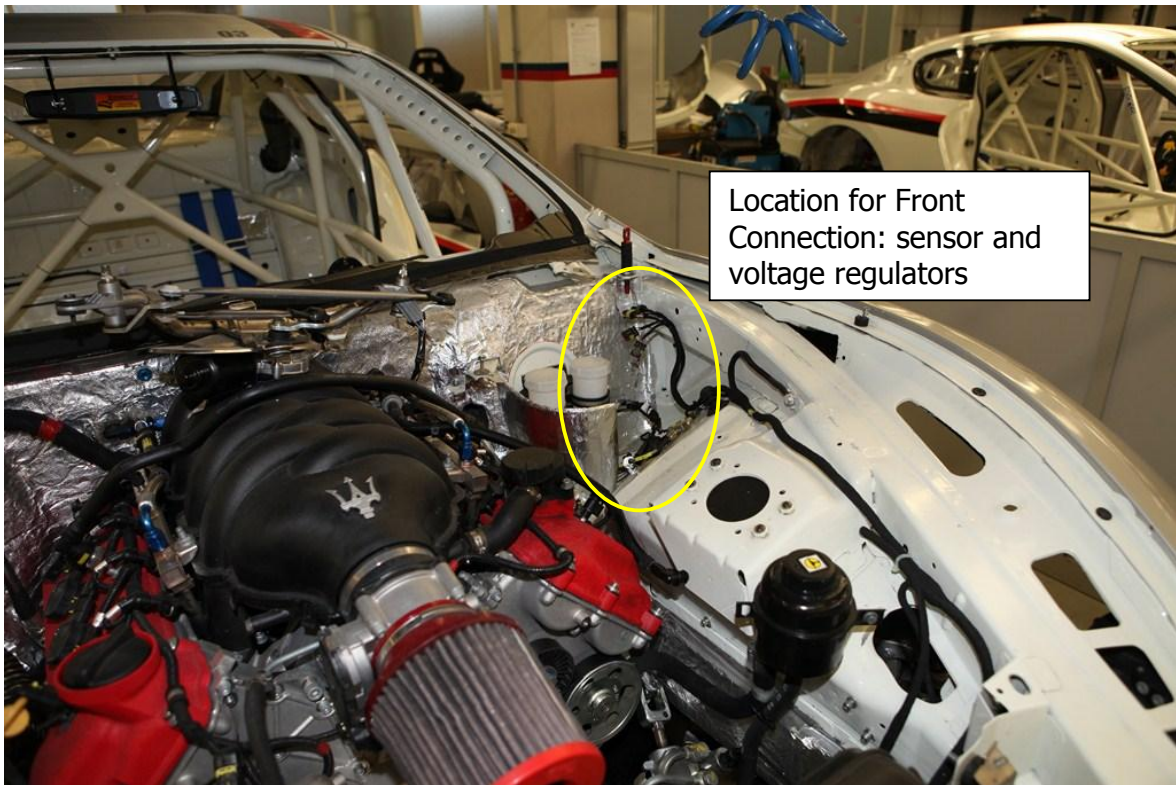
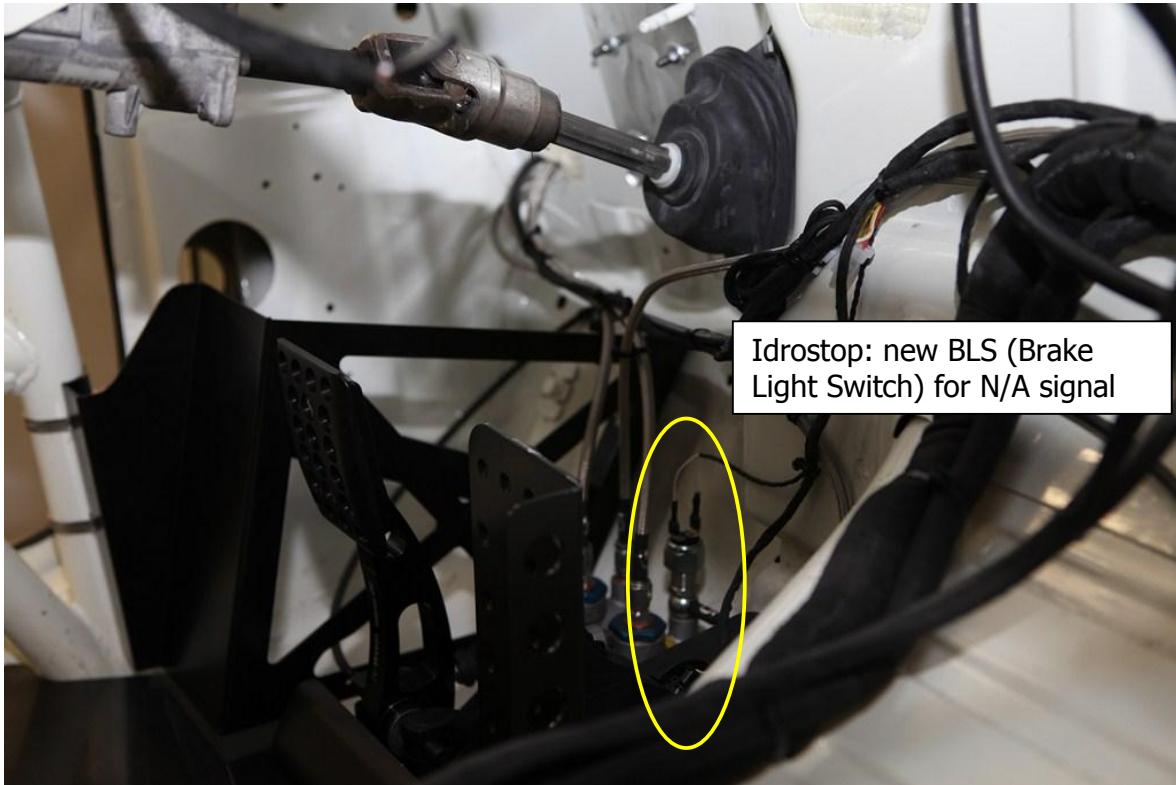

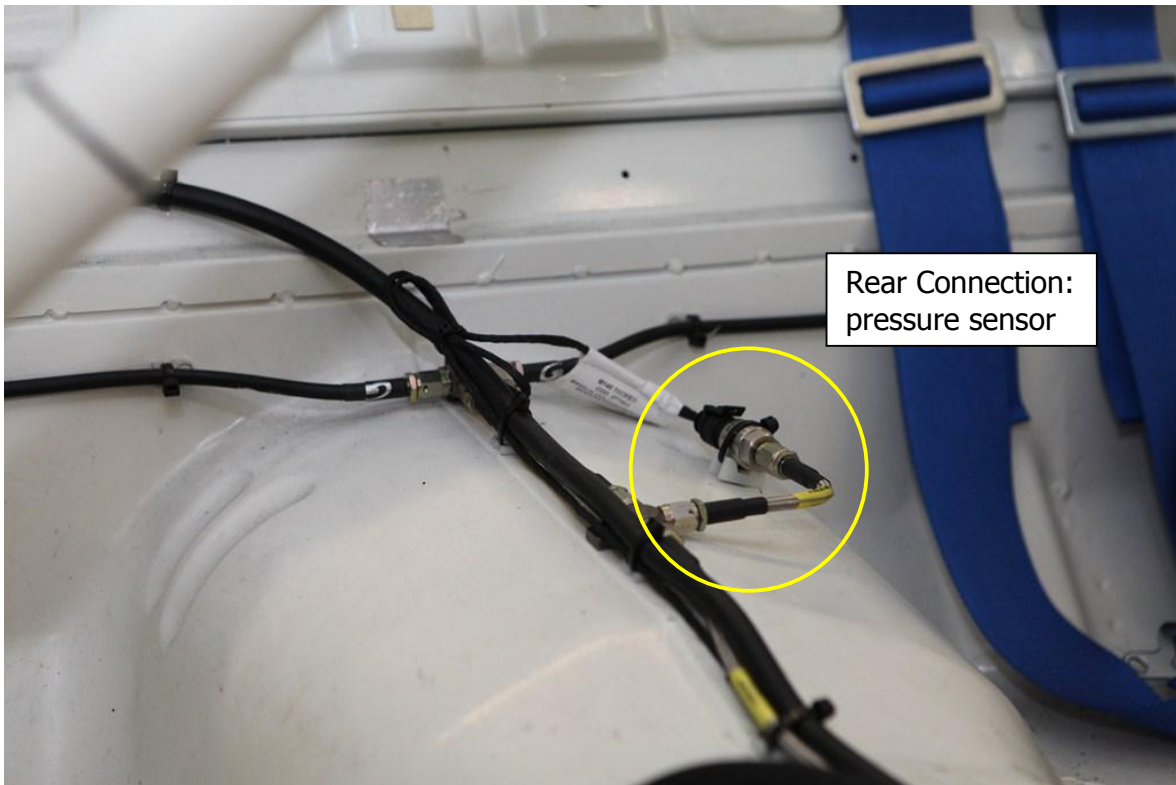
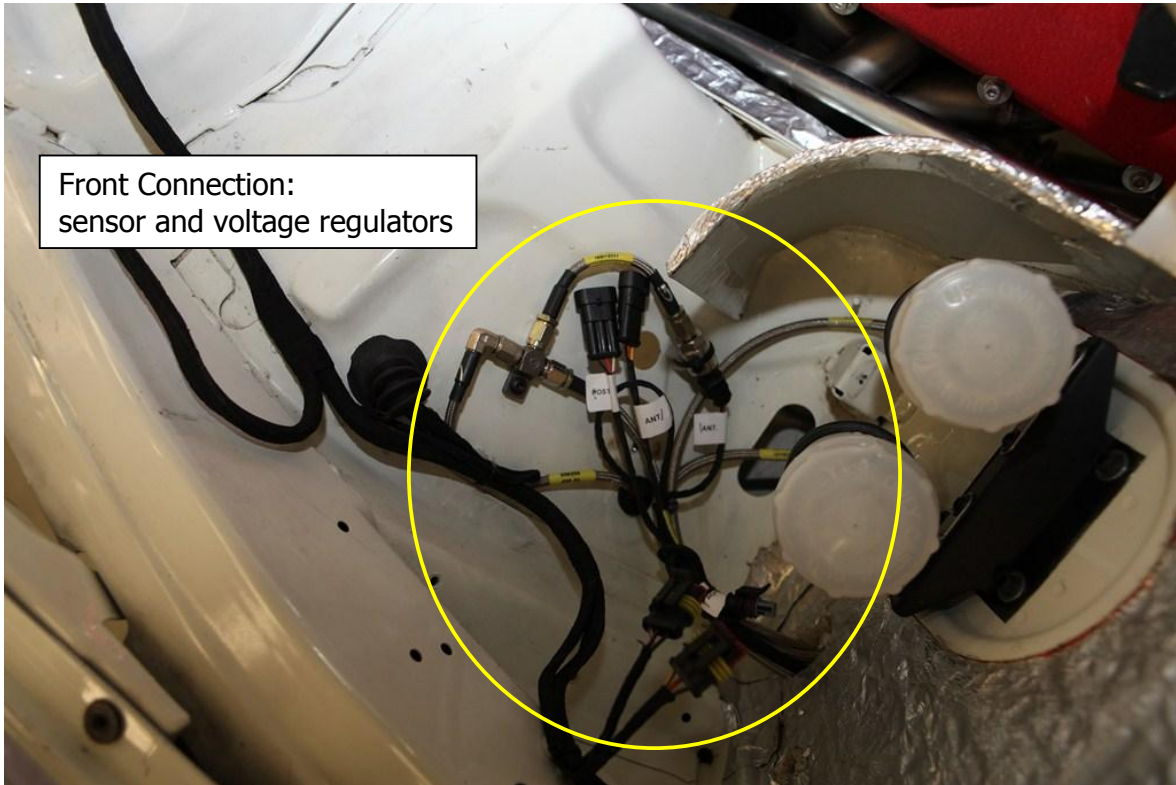

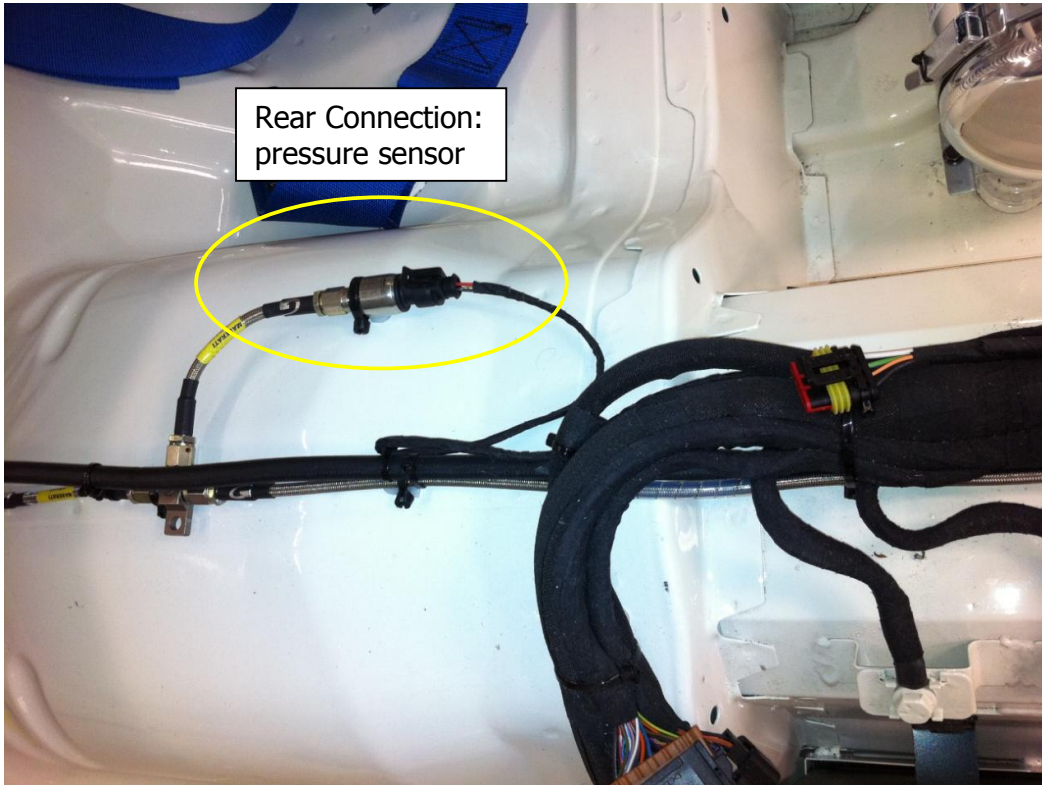

15.4. CAN connector

It is possible to connect a CAN data logger by using directly the free connectors on the vehicle.

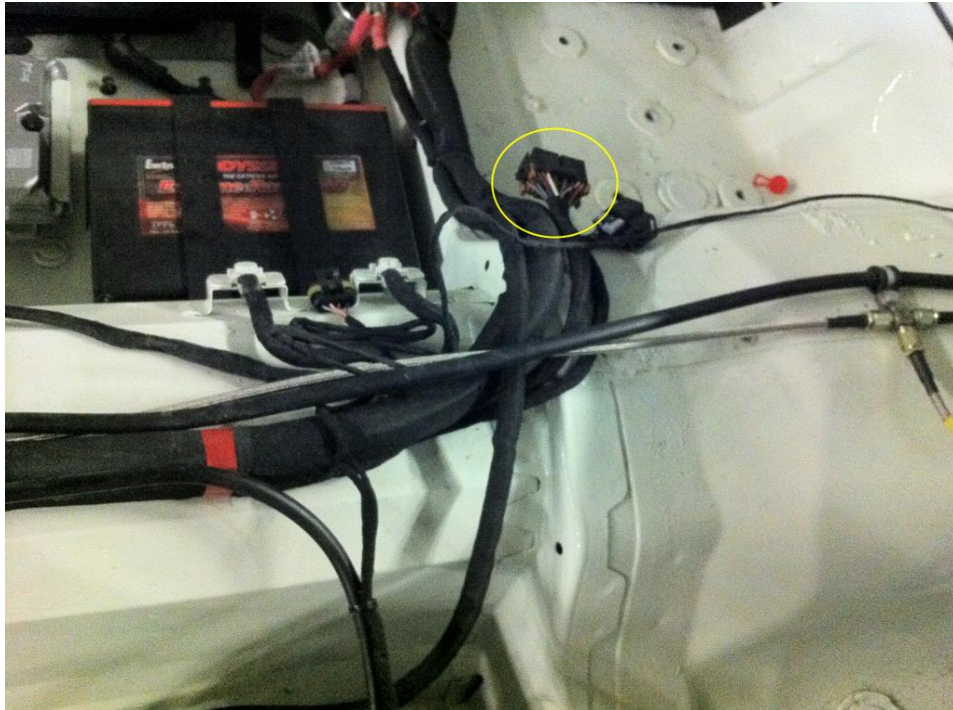
Vehicle connector

40 way plastic join connector

Pin 3A – CAN_High (white wire)

Pin 4A – CAN_Low (green wire)

Download / Configuration cable

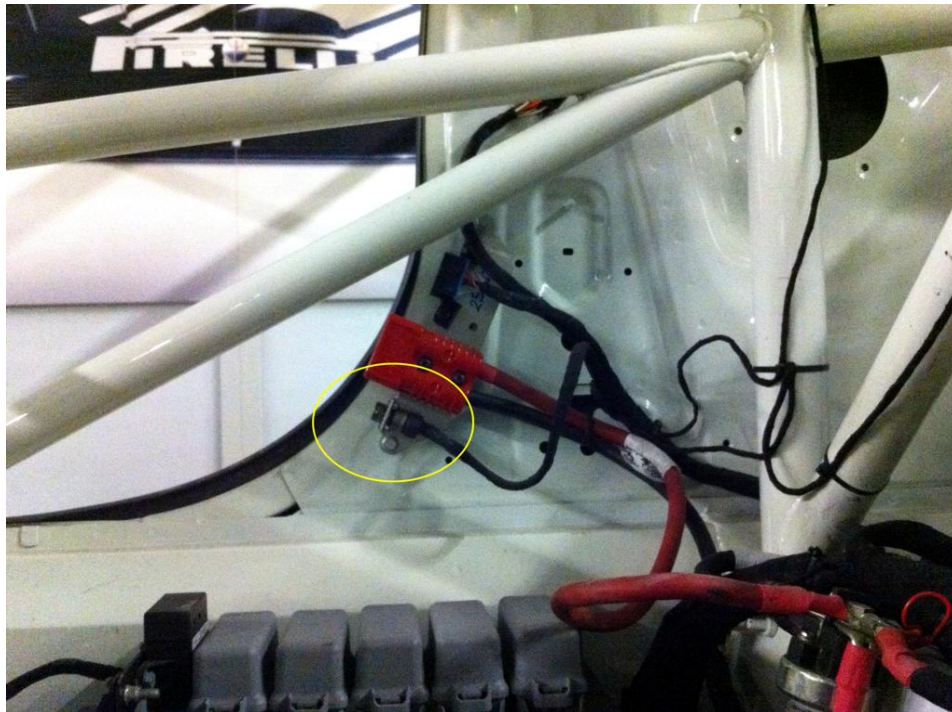

6 way military join connector

Maserati Ethernet Data Cable (w/o CAN connection) p/n: 232816

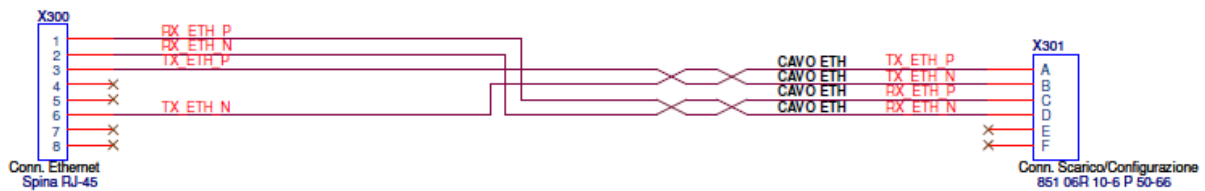

Connector X301 (Cod. Souriau: 851 06R 10-6 P 50-66)

- Pin A – Ethernet TX Positive
- Pin B – Ethernet TX Negative
- Pin C – Ethernet RX Positive
- Pin D – Ethernet RX Negative
- Pin E – CAN_High (white wire)
- Pin F – CAN_Low (green wire)



16. GT4 upgrade kit 2016

According to the requirements set by SRO for the homologation of the car to GT4 regulation, the following parts must be modified/replaced as described below:

Part Number	Description	Modification
980145529	Front splitter	Resize and replace the fixing holes (*)
980145546	Rear diffuser	Re-shape and reinforce (*)
980145320	Front bumper	Re-shape the lower lip (*)
980144960	Rear Wing	Resize and re-shape (*)
980144958	Wing pylons	Replace with new part
TBA	Air restrictor	Add the 64,4mm flange and spacer

(*) The drawings and instruction to modify the affected parts are provided with the 2016 GT4 upgrade available on sale

17. Specific maintenance tools

The following special tools are provided by Maserati as Maintenance tool kit

Part Number	Description
263960	Maserati Diagnostic tool by Waycon
900027836	Fuel draining hose + fuel pump connection harness
232816	Ethernet cable datalogger
264585	Transmitter
900026390	FUEL PUMP RING NUT TIGHTENING TOOL

It's recommended to have a 41 mm HEXAGONAL SOCKET (not provided by Maserati) to work on driveshafts and the hub preload screws.

Other ManualsLib Projects



www.manualslib.com



www.manualslib.de



www.manualslib.es



www.manualslib.fr



www.manualslib.nl



www.manualslib.mx



www.manualslib.tech 30+ Languages